



LIBRARY

# INSTALLATION GUIDE AND USER MANUAL

Sol-Ark 15K-2P-N

V1.2

Sep 25, 2023

RESIDENTIAL  
NORTH AMERICA







## READ THE INSTRUCTIONS COMPLETELY BEFORE OPERATING THE EQUIPMENT



Check the utility voltage before turning ON the unit.



Verify the inviter's programmed grid type before connecting to the utility.



The unit will be programmed in 120/240V Split-Phase at 60Hz by default.

**Disregarding these instructions could result in permanent damages to the unit**

## DISCLAIMER

UNLESS SPECIFICALLY AGREED TO IN WRITING, SOL-ARK:

(A) DOES NOT WARRANT THE ACCURACY, SUFFICIENCY OR SUITABILITY OF ANY TECHNICAL OR OTHER INFORMATION PROVIDED IN ITS MANUALS OR OTHER DOCUMENTATION.

(B) ASSUMES NO RESPONSIBILITY OR LIABILITY FOR ANY LOSS OR DAMAGES, WHETHER DIRECT, INDIRECT, CONSEQUENTIAL, OR INCIDENTAL, ARISING OUT OF THE USE OF SUCH INFORMATION. USE OF SUCH INFORMATION SHALL BE ENTIRELY AT THE USER'S RISK.

Sol-Ark is not responsible for system failure, damage or injury resulting from improper installation of its products.

Information in this manual is subject to change without notice.

This manual is only focused on the inverter labeled as: 15K-2P-N.

### Contact

Phone: (USA) +1 (972) 575-8875 ext. (2)

Email: [SUPPORT@SOL-ARK.COM](mailto:SUPPORT@SOL-ARK.COM)

Website: [WWW.SOL-ARK.COM](http://WWW.SOL-ARK.COM)

# Table of Contents

|  |           |
|--|-----------|
| IMPORTANT SAFETY INSTRUCTIONS .....                            | 5         |
| <b>1. Sol-Ark: First Glance .....</b>                          | <b>6</b>  |
| 1.1 General Description.....                                   | 7         |
| 1.2 Specifications.....  | 8         |
| 1.3 Wire Gauge Guide.....                                      | 10        |
| <b>2. Installation.....</b>                                    | <b>11</b> |
| 2.1 Mounting the Sol-Ark .....                                 | 11        |
| 2.2 Integrating Batteries .....                                | 13        |
| 2.3 Connecting PV Modules .....                                | 15        |
| 2.4 Integrating a Generator .....                              | 16        |
| 2.5 Grid Peak Shaving.....                                     | 17        |
| 2.6 Automatic Generator Start.....                             | 17        |
| 2.7 Integrating Sensors and Accessories.....                   | 18        |
| 2.8 Limit Sensors (CT sensors).....                            | 19        |
| 2.9 Emergency Stop and Rapid Shutdown.....                     | 21        |
| 2.10 Powering-up and Testing the Sol-Ark .....                 | 22        |
| 2.11 Power Cycle Sequence .....                                | 23        |
| 2.12 LED Indicators .....                                      | 23        |
| 2.13 Main screen (Touchscreen).....                            | 23        |
| <b>3. User Interface.....</b>                                  | <b>25</b> |
| 3.1 Basic Setup.....   | 25        |
| 3.2 Battery Setup .....  | 26        |
| 3.3 Limiter .....  | 28        |
| 3.4 Grid Setup .....   | 32        |
| 3.5 Programming Guide.....                                     | 33        |
| <b>4. Installation Tips .....</b>                              | <b>34</b> |
| 4.1 Battery Charge Controller .....                            | 34        |
| 4.2 Battery Communication with MODBUS/CANBUS .....             | 35        |
| 4.3 Grid Compliance Settings .....                             | 36        |
| <b>5. Parallel Systems .....</b>                               | <b>37</b> |
| 5.1 Before Enabling Parallel Operations .....                  | 37        |
| 5.2 Parallel Systems Programming Sequence .....                | 38        |
| 5.3 Three-Phase Systems: Programming and Troubleshooting ..... | 40        |
| <b>6. Wi-Fi / Ethernet Connection.....</b>                     | <b>42</b> |
| 6.1 Ethernet Connection .....                                  | 42        |
| 6.2 Wi-Fi (PC or Smart Phone).....                             | 42        |
| <b>7. Wiring Diagrams .....</b>                                | <b>47</b> |
| <b>8. Troubleshooting Guide.....</b>                           | <b>58</b> |
| 8.1 Sol-Ark error codes.....                                   | 60        |
| <b>9. Install Verification .....</b>                           | <b>61</b> |
| 9.1 Warranty Checklist.....                                    | 61        |
| 9.2 Limited Warranty: Sol-Ark 15K-2P-N.....                    | 62        |
| <b>10. GUI Screens .....</b>                                   | <b>63</b> |

# IMPORTANT SAFETY INSTRUCTIONS

## SYMBOLS THAT APPEAR IN THIS DOCUMENT

 **WARNING:** This symbol indicates information that, if ignored, could cause serious injury, equipment damage, or death.

 **CAUTION:** This symbol indicates information that, if ignored, could result in minor injury or equipment damage.

 **NOTE:** This symbol indicates relevant information that is not related to hazardous situations.

## WARNINGS

 Read this entire document before installing or using the Sol-Ark 15K-2P-N inverter. Failure to follow any of the instructions or warnings in this document can result in electrical shock, serious injury, or death. Damage to the 15K-2P-N inverter is also possible, potentially rendering it inoperable.

 High Life Risk due to fire or electrocution - ONLY qualified persons should install the Sol-Ark inverter.

 The system must have Ground connections and Neutral connections. Ground MUST be bonded to Neutral ONLY ONCE in the circuit.

 Solar PV+/PV- are UNGROUNDED. Note, you may ground PV Racking/Mounts, but doing so directly to the Sol-Ark will likely result in damage in the case of a direct lightning strike to the PV array.

 DO NOT connect the grid to the "LOAD" output terminal.

 DO NOT reverse the polarity of batteries. Damage WILL occur.

 DO NOT exceed 500V<sub>oc</sub> on any MPPT on the Sol-Ark.

 DO NOT turn off the battery breaker if there is current flowing in or out of the battery in any amount.

 DO NOT use impact drivers to tighten any fasteners on the Sol-Ark.

 MUST use conduit (or double insulated wire) for AC wires entering/exiting Sol-Ark user area.

 ALL terminals/breakers, including battery, MPPT, and AC Terminal Block inputs, should only have one conductor connected to them.

# 1. Sol-Ark: At a First Glance

## INSPECT SHIPMENT

The box should include all items shown in the component guide. If there is damage or missing parts, immediately call the phone number (USA) +1 (972) 575-8875 Ext. 2.

## COMPONENT GUIDE

The Sol-Ark 15K-2P-N system includes the following components:

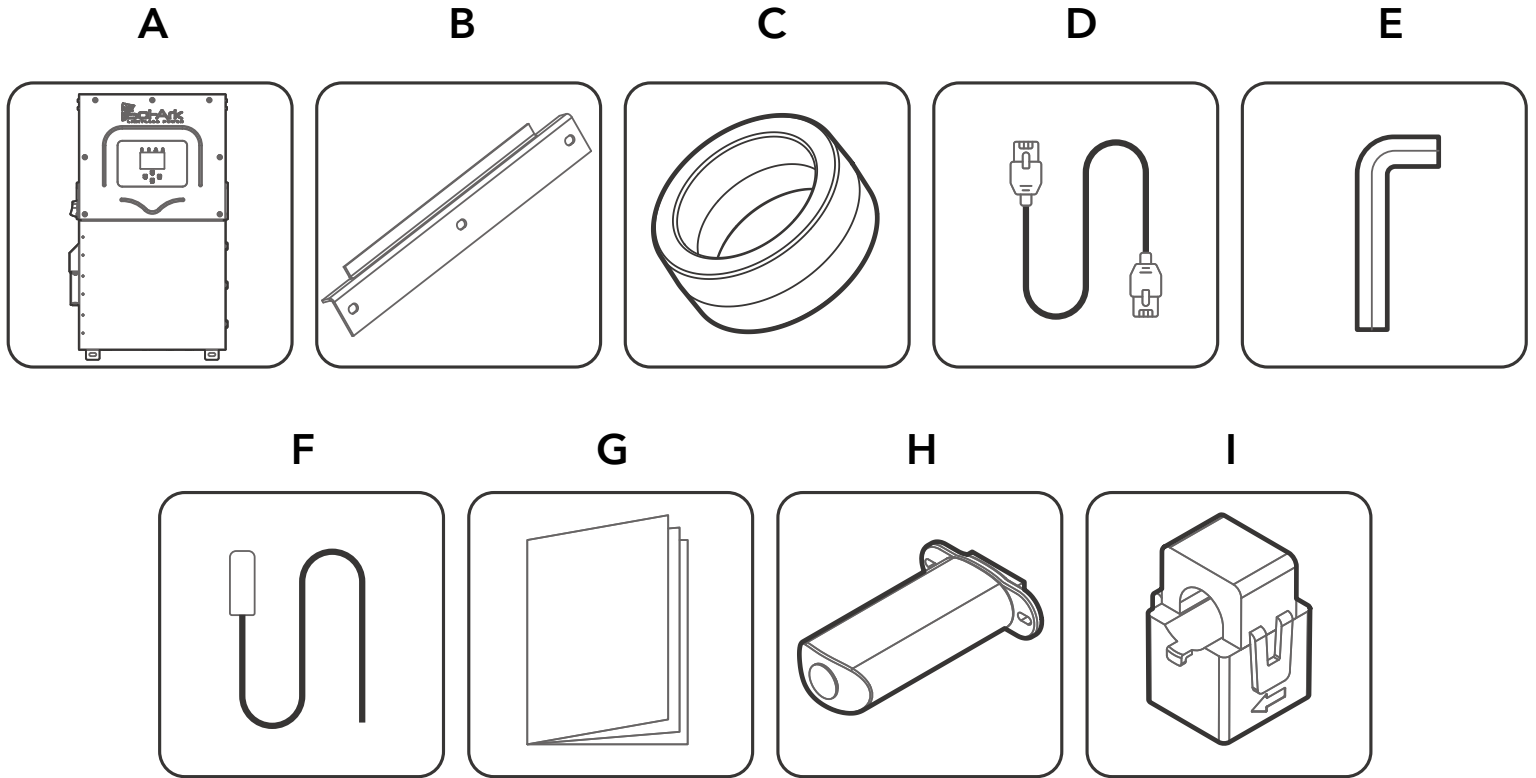

| Component | Description                       | Quantity |
|-----------|-----------------------------------|----------|
| A         | Sol-Ark 15K-2P-N inverter         | 1        |
| B         | French cleat                      | 1        |
| C         | Battery toroid                    | 2        |
| D         | CAT 5E communication cable        | 1        |
| E         | Allen key (4 mm)                  | 1        |
| F         | Temperature sensor                | 1        |
| G         | User manual                       | 1        |
| H         | Wi-Fi / Ethernet antenna (dongle) | 1        |
| I         | Current transformer sensors (CTs) | 2        |

# 1.1 General Description

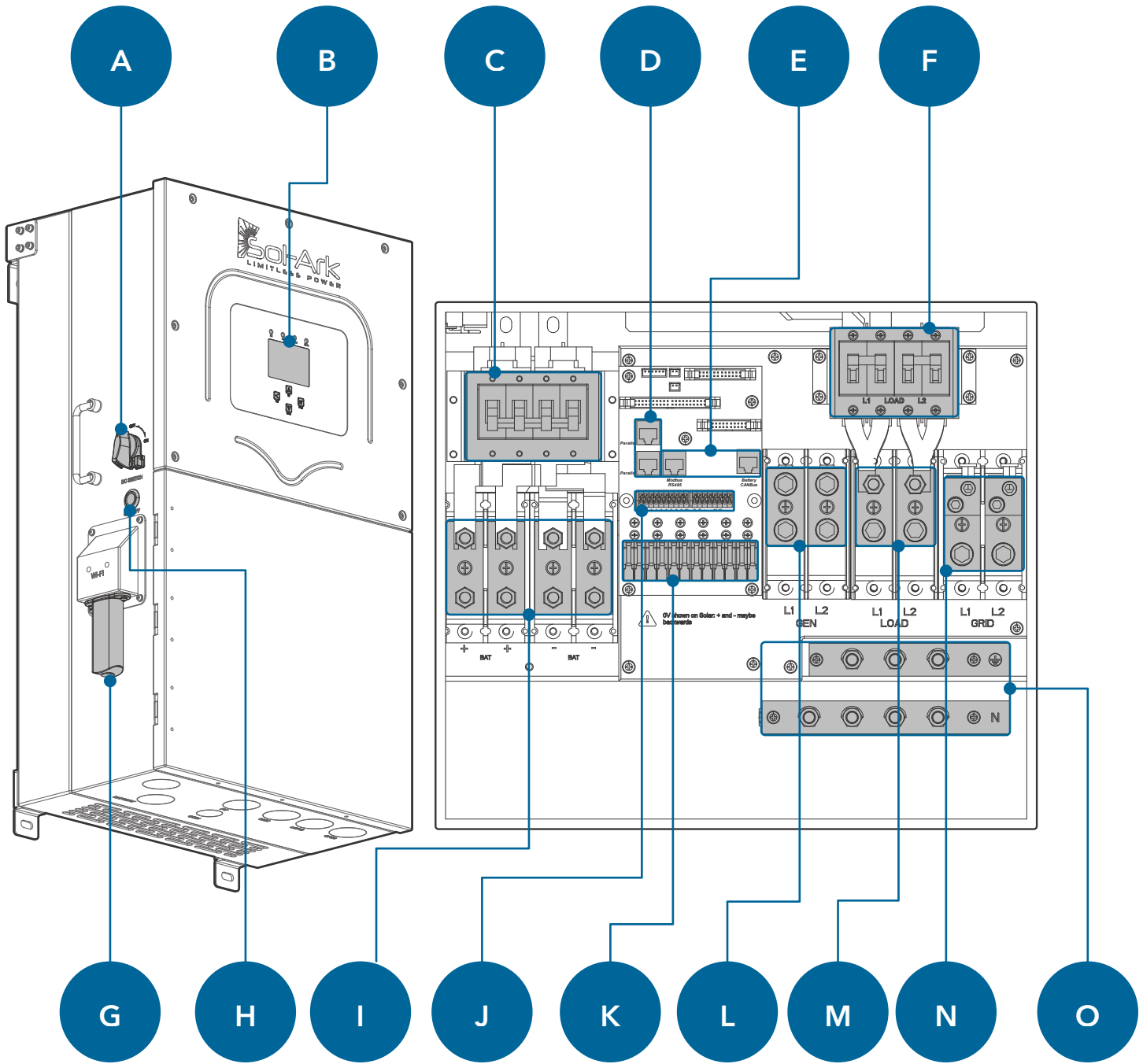

| Component | Name                         | Component | Name                                      |
|-----------|------------------------------|-----------|---|
| A         | PV DC disconnect             | I         | Input pinouts for sensors and accessories |
| B         | LCD touch screen             | J         | Battery terminals                         |
| C         | X2 (200A) battery breakers   | K         | MPPT inputs                               |
| D         | Parallel RJ45 ports          | L         | (100A) GEN terminal                       |
| E         | BMS RJ45 ports (RS485 / CAN) | M         | (200A) LOAD terminal                      |
| F         | (200A) LOAD breaker          | N         | (200A) GRID terminal                      |
| G         | Wi-Fi / Ethernet dongle      | O         | GROUND / NEUTRAL Busbars                  |
| H         | ON / OFF Button              |           |   |

# 1.2 Specifications

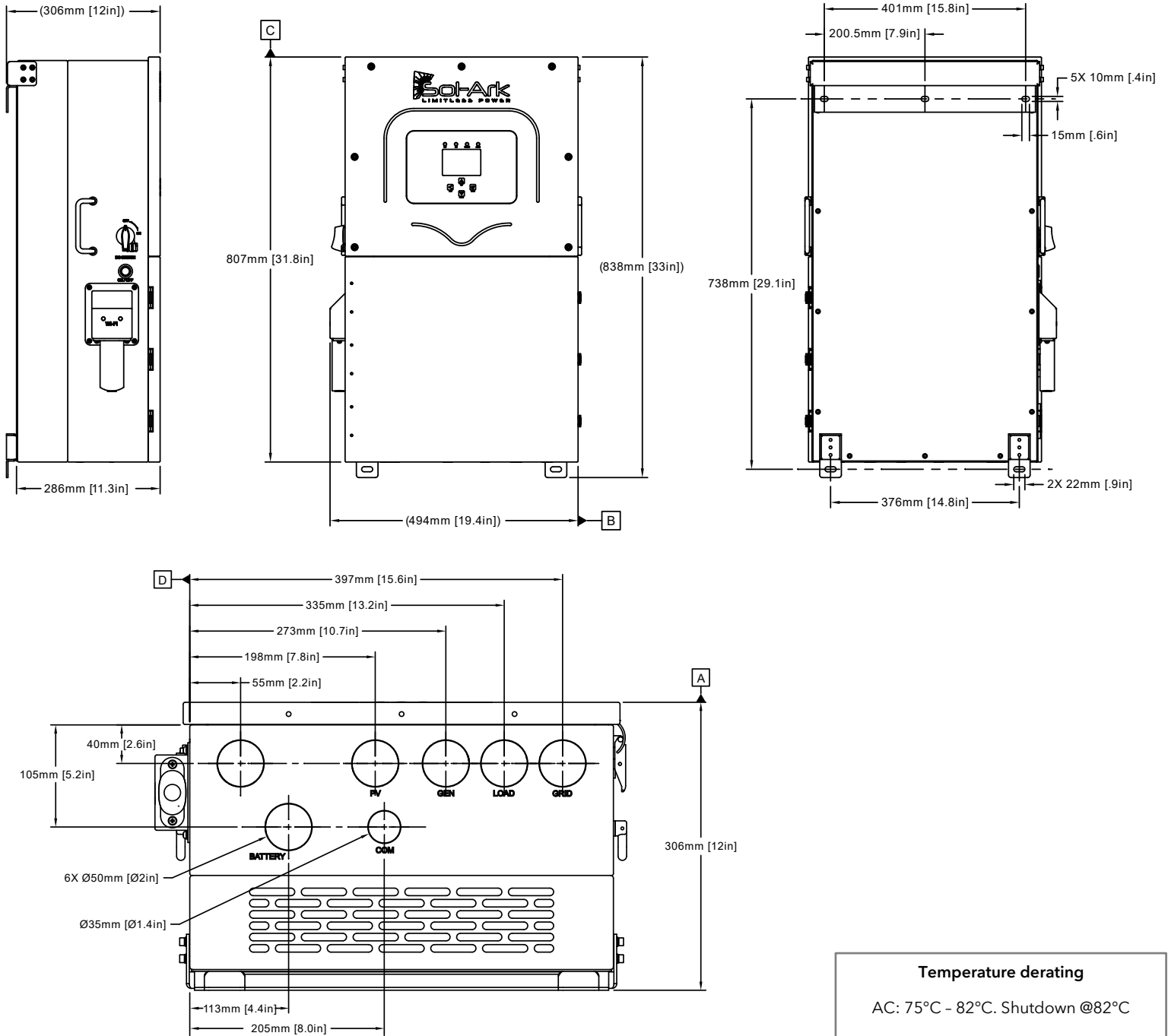

### SOL-ARK 15K-2P-N TORQUE VALUES APPLICATION NOTE

| Terminal                  | Torque [in-lb] | Torque [Nm] |
|---------------------------|----------------|-------------|
| LOAD                      | 165 in-lb      | 18.6 Nm     |
| GRID                      | 165 in-lb      | 18.6 Nm     |
| GEN                       | 165 in-lb      | 18.6 Nm     |
| Neutral / Ground (Busbar) | 121 in-lb      | 13.7 Nm     |
| Cover Screws              | 15.5 in-lb     | 1.75 Nm     |
| Battery Connection        | 90 in-lb       | 10 Nm       |

Do not use impact drivers to tighten any fasteners on the Sol-Ark





## Datasheet

## UL: Limitless 15K-LV

### Input Data (PV)

|                             |                     |
|-----------------------------|---------------------|
| Max. Allowed PV Power (STC) | 19,500W             |
| Nominal Voltage Range       | 175 - 425V          |
| Startup Voltage             | 125V                |
| Max. Input Voltage          | 500V                |
| Max. Input Current per MPPT | 26A (self-limiting) |
| No. of MPP Trackers         | 3                   |
| No. of PV Strings per MPPT  | 2                   |
| Max. AC Coupled Input       | 19,200 W            |

### Output Data (AC)

|  |  |
|--|--|
| Nominal AC Voltage                                 | 120/240V, 120/208V, 220V                 |
| Grid Frequency                                     | 50 / 60Hz                                |
| Real Power, max continuous                         | 15,000W                                  |
| Max. Output Current                                | 62.5A                                    |
| Real Power, max continuous (batteries only, no PV) | 12,000W (50A @ 240V)                     |
| Peak Apparent Power (10s, off-grid)                | 24,000VA @ 240V                          |
| Peak Apparent Power (100ms, off-grid)              | 30,000VA @ 240V                          |
| Max Output Fault Current (5s)                      | 94A with PV, 75A (batteries only, no PV) |
| Max Output Fault Current (100ms)                   | 120A                                     |
| Max. Grid Passthrough Current                      | 200A                                     |
| Power Factor Output Range                          | +/- 0.9 adjustable                       |
| Backup Transfer Time                               | 5ms                                      |
| CEC Efficiency                                     | 96.5%                                    |
| Max Efficiency                                     | 97.5%                                    |
| Design (DC to AC)                                  | Transformerless DC                       |
| Stackable  | Up to 12 in parallel                     |

### Battery Input Data (DC)

|   |                           |
|---|---------------------------|
| Battery Technologies                    | Lithium / Lead Acid       |
| Nominal DC Voltage                      | 48V                       |
| Operating Voltage Range                 | 43 - 63V                  |
| Capacity                                | 50 – 9900Ah               |
| Max. Battery Charge / Discharge Current | 275A                      |
| Charging Controller                     | 3-Stage with Equalization |
| Grid to Battery Charging Efficiency     | 96.0%                     |
| External Temperature Sensor             | Included                  |
| Current Shunt for Accurate % SOC        | Integrated                |
| Automatic Generator Start               | Integrated                |
| Communication to Lithium                | CANBus & RS485            |

### General Data

|                            |  |
|----------------------------|--|
| Dimensions (H x W x D)     | 807 x 494 x 306 mm / 31.8 x 19.4 x 12 in |
| Weight                     | 61.2 Kg / 135 lb.                        |
| Enclosure                  | IP65 / NEMA 3R                           |
| Ambient Temperature        | -25~55°C, > 45°C Derating                |
| Noise                      | < 30 dB                                  |
| Idle consumption - No Load | 90W                                      |
| Wi-Fi & LAN Communication  | Included                                 |
| Standard Warranty          | 10 Years                                 |

### Protection and Certifications

|   |                         |
|---|-------------------------|
| Electronics Certified Safety by SGS Labs to NEC & UL Specs - NEC 690.4B & NEC 705.4/6                       | Yes                     |
| Grid Sell Back – UL1741-2010/2018, IEEE1547a 2003/2014, FCC 15 Class B, UL1741SB, CA Rule 21, HECO Rule 14H | Yes                     |
| PV DC Disconnect Switch – NEC 240.15  | Integrated              |
| Ground Fault Detection – NEC 690.5  | Integrated              |
| PV Rapid Shutdown Control – NEC 690.12  | Integrated              |
| PV Arc Fault Detection – NEC 690.11   | Integrated              |
| PV Input Lightning Protection   | Integrated              |
| PV String Input Reverse Polarity Protection   | Integrated              |
| AC Output Breaker - 200A  | Integrated              |
| 200A x 2 Battery Breaker / Disconnect   | Integrated              |
| Surge Protection  | DC Type II / AC Type II |

# 1.3 Wire Gauge Guide

## 1. AC Input/Outputs:

- "GRID" Terminal 200A MAX → 200A passthrough, 1/0 AWG to 4/0 AWG conductor.
- "LOAD" Terminal 200A MAX → 200A passthrough, 1/0 AWG to 4/0 AWG conductor.

Wire gauge should be selected in compliance with your local electrical code

2. **SENSORS:** 24-20 AWG
3. **SENSORS CT:** 13 ft [4 m] included.
4. **BATTERY TEMPERATURE SENSOR:** Included 9.8 ft [3 m] sensor
5. **CABLE RJ45:** Included 6.5 ft [2 m]. Extendable up to 20 ft [6 m]
6. **BATTERY CABLES:** 4/0 AWG THHN / Max Charge and Discharge limited to 275A

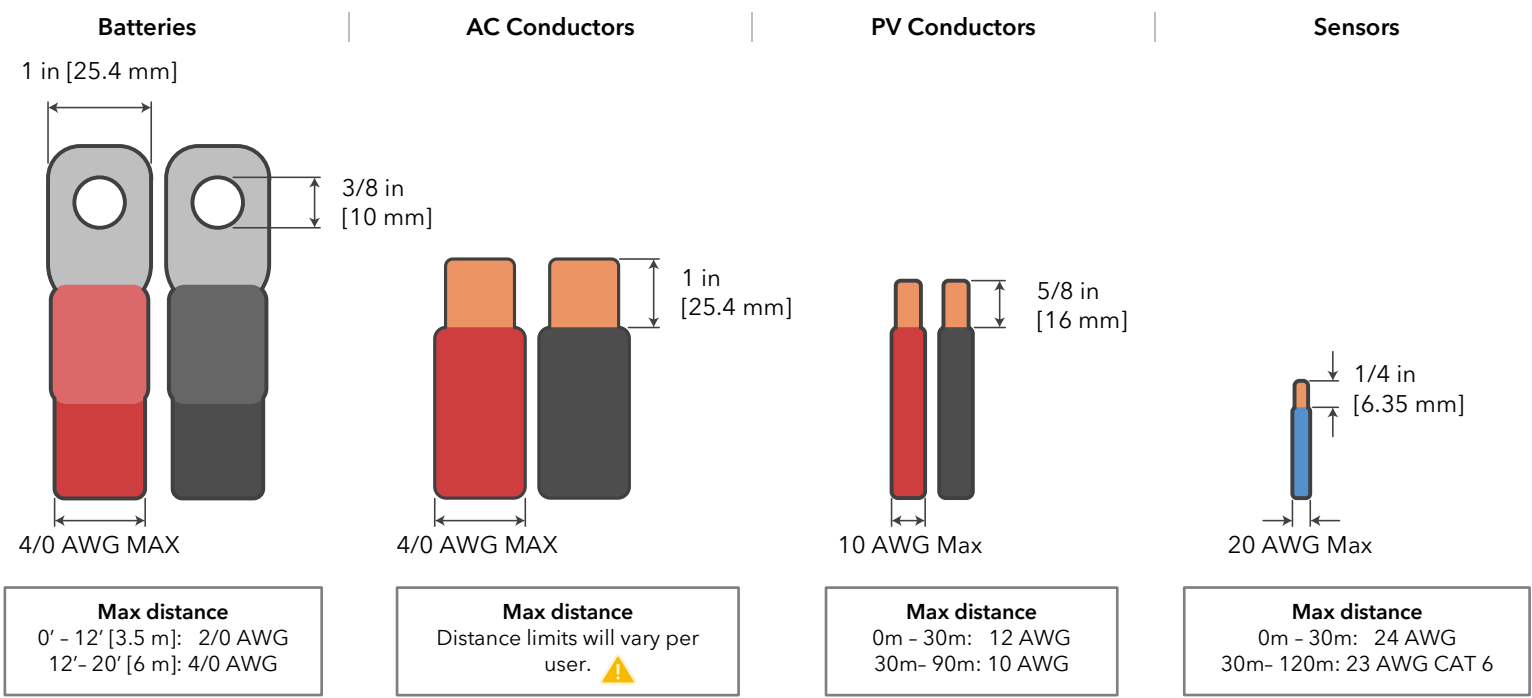

### CT Sensors (Included)

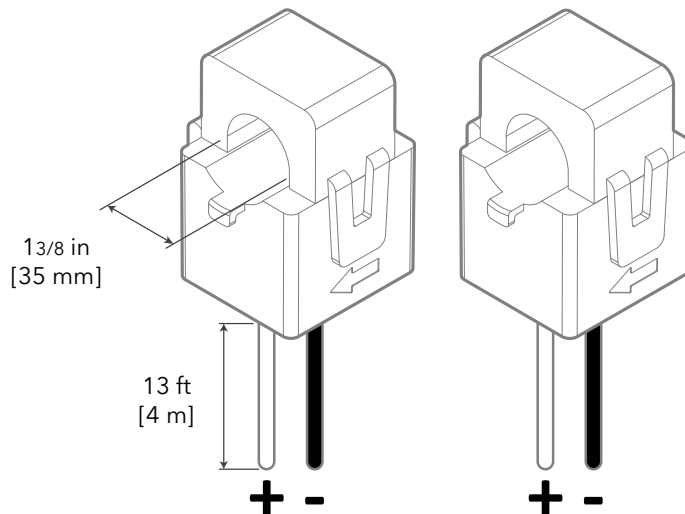

## 2. Installation

### Backup Circuits

- The sub panel powered by the "LOAD" terminal will be considered the Essential Loads Panel.
- You must keep the essential loads panel within the limitations of the unit:
  - Grid Tie → 48 kW = 200A continuous @ 240V (passthrough).
  - Off-Grid → 15kW = 62.5A @ 240V (PV & battery) | 12kW = 50A @ 240V (batteries only)
- Verify that every load circuit power ( $P=V*I$ ) does not surpass the aforementioned limits.

### Single System Install

- FOR PARTIAL BACKUP:** Connect the output of your back-feed breaker or line side tap (depending on the point of interconnection) to the "GRID" terminal.
  - A disconnect of 200A must be installed between the interconnection and the Sol-Ark to protect the inverter and conductors.
  - Connect the "LOAD" output to the Essential Loads Panel using 1/0 AWG to 4/0 AWG conductors
- FOR WHOLE-HOME BACKUP:** Connect the incoming grid directly to the "GRID" input terminal.
  - An external disconnect of 200A must be installed between the grid and the Sol-Ark to protect the inverter and conductors.
  - Connect the "LOAD" output to the Main Service Panel using 1/0 AWG to 4/0 AWG conductors.

It is possible to connect a generator or an AC coupled source (80A max or 19,200W) such as string or micro inverters to the "GEN" terminal of the inverter. Only one AC source can be connected to the "GEN" terminal at a time.

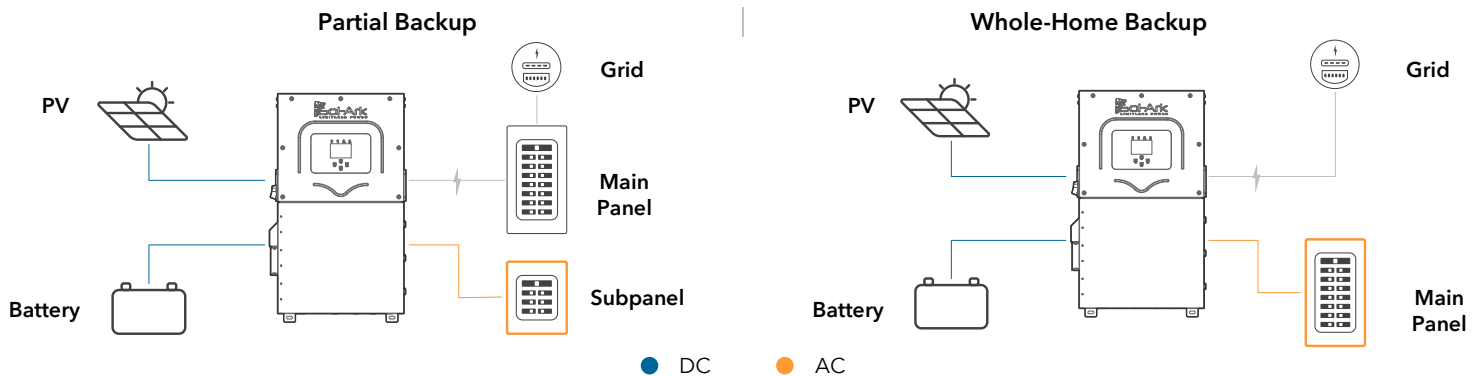

Figure 1: Partial backup or whole-home backup installs

### 2.1 Mounting the Sol-Ark

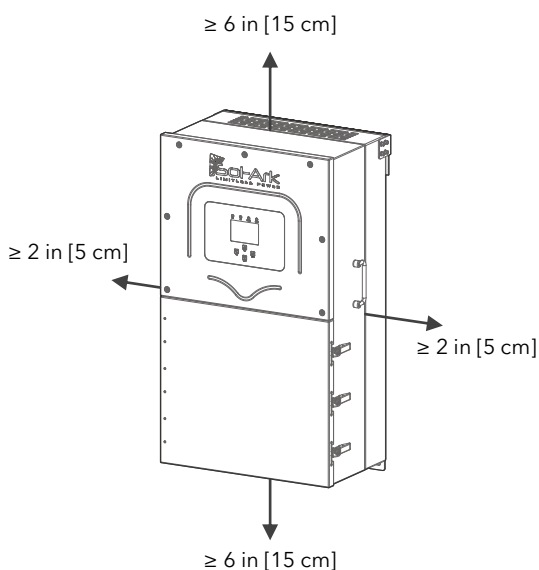

Figure 2: Unit clearances

- The system weight is 135 lb / 61 kg.
- Considering the dimensions of the inverter, find a suitable location for the system(s). There must be at least 6 in [15 cm] of vertical clearance for proper heat dissipation.



Heat transfer and cooling is done from bottom to top at a rate of 525W/hr

- The Sol-Ark 15K-2P-N is a NEMA 3R - IP65 enclosure that is rated for outdoor installation but can also be installed indoors.
- ⚠️ PROTECT THE LCD SCREEN** from direct exposure to UV light.
- Mount the Sol-Ark and ensure the unit is level and properly seated.
- Securely attach the inverter to the mounting surface. You may need expansion plugs or anchors for concrete. In case a different anchorage is required, calculate the support needed to properly hold the weight of the equipment.

G. Use five (5) screws and washers (choose screw length/diameter based on surface type).

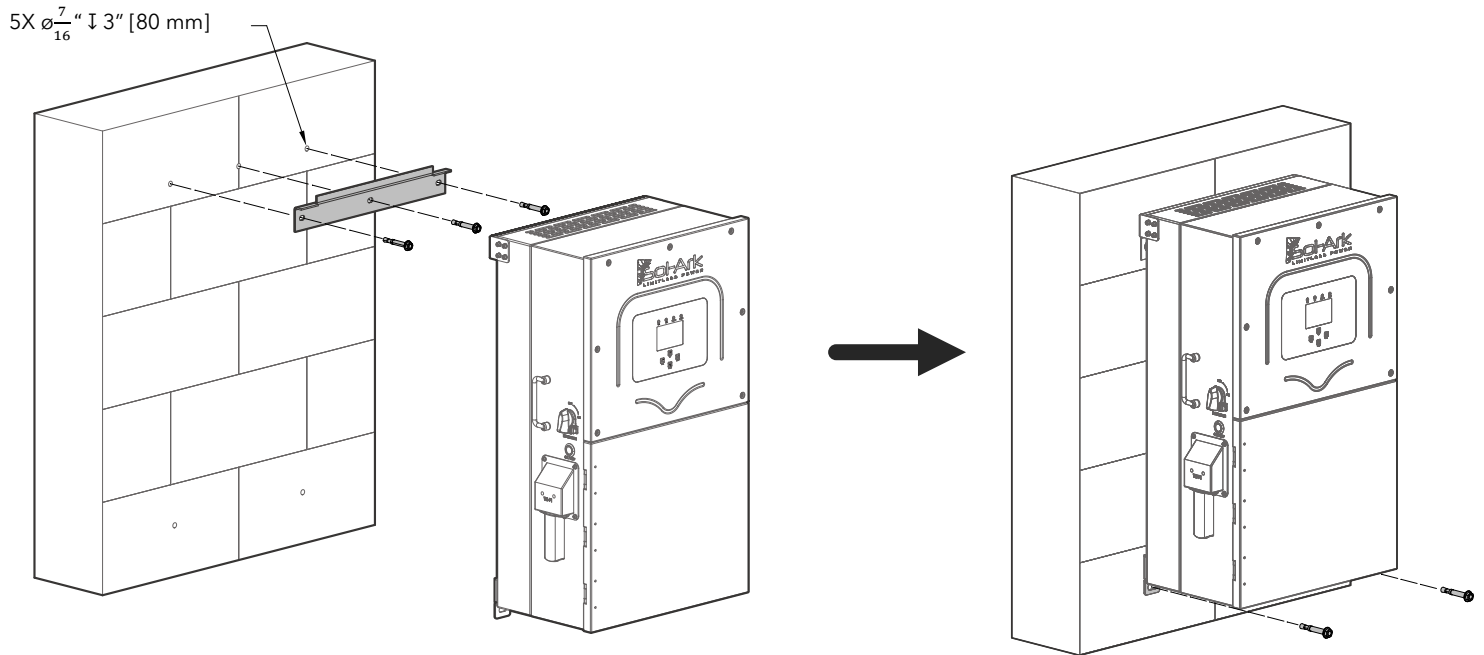

Figure 3: Wall Mount

Damage to the LCD Screen due to direct sunlight exposure will not be covered by warranty

H. Mount the inverter in the optimal orientation as shown below.

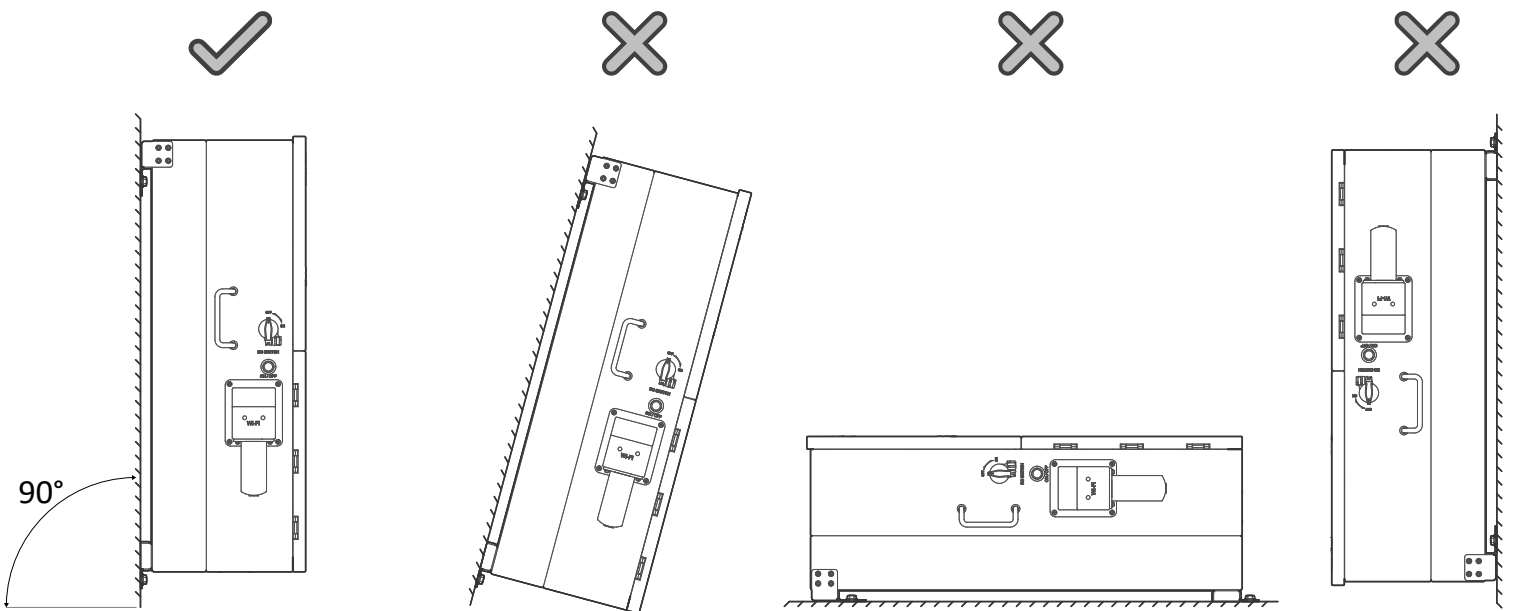

Figure 4: Best practice for mounting orientation

## 2.2 Integrating Batteries

- A. ⚠ Sol-Ark 15K-2P-N must be OFF while the batteries are being connected.
- B. Depending on the battery voltage, wire up the battery bank in the possible configurations shown in figures 5a-5c.
- C. Battery breakers must be OFF when wiring. If your battery bank does not have internal breakers, maintain the necessary safety measures when handling.
- D. ⓘ The 15K-2P-N reaches a max battery charge/discharge of 275A if using both sets of battery terminals. If only one set of terminals is used, the max battery charge/discharge will be limited to 160A.

⚠ Sol-Ark 15K-2P-N is a **48V nominal system**. **DO NOT** connect the inverter to any other battery configuration. If you use 12V batteries, you **MUST NOT** exceed four (4) batteries in series, as shown in Figure 5b. The inverter can work with any battery chemistry as long as it remains within the range of **43V to 63V**.

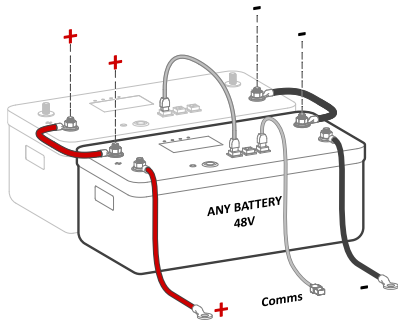

Figure 5a: 48V batteries in parallel connection

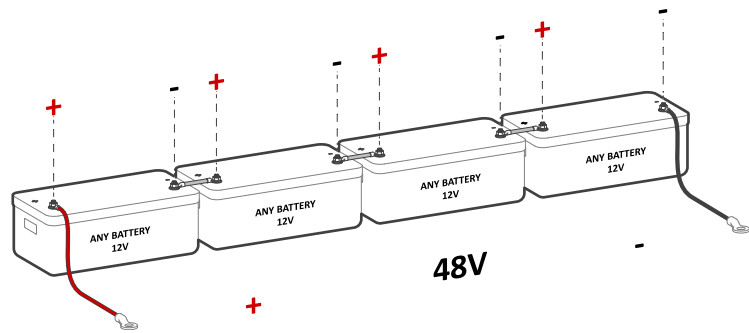

Figure 5b: 12V batteries in series connection

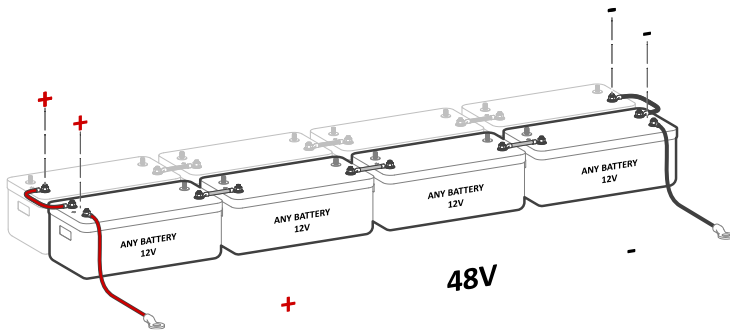
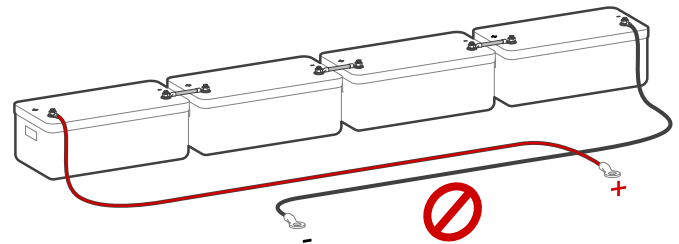

Figure 5c: Series and parallel connections for complete 48V batt bank



⚠ **DO NOT** reverse polarity. The system will be damaged, and warranty will be voided!

### Battery Toroid

Install the battery toroids on battery input wires, as shown in the following figure. Battery (+) and (-) cables must go through both toroids simultaneously. If dealing with four (4) wires, all conductors must go through the toroids as shown below.

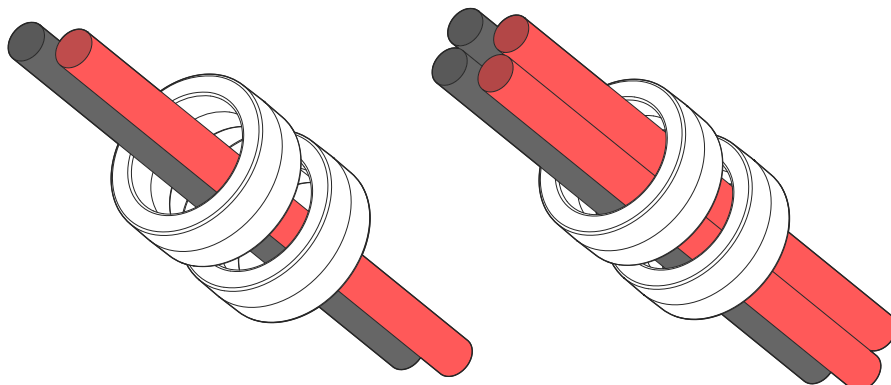

Figure 6: Battery toroid installation

## Multi-Terminal Installation

The two battery input terminals of the 15K-2P-N will parallel batteries internally to ensure a common connection between battery banks and simplify battery installations. If a charge / discharge rate of 275A is needed, the batteries must be connected to both input terminals. If using 3 or more batteries, use external busbars for (+) and (-) connections.

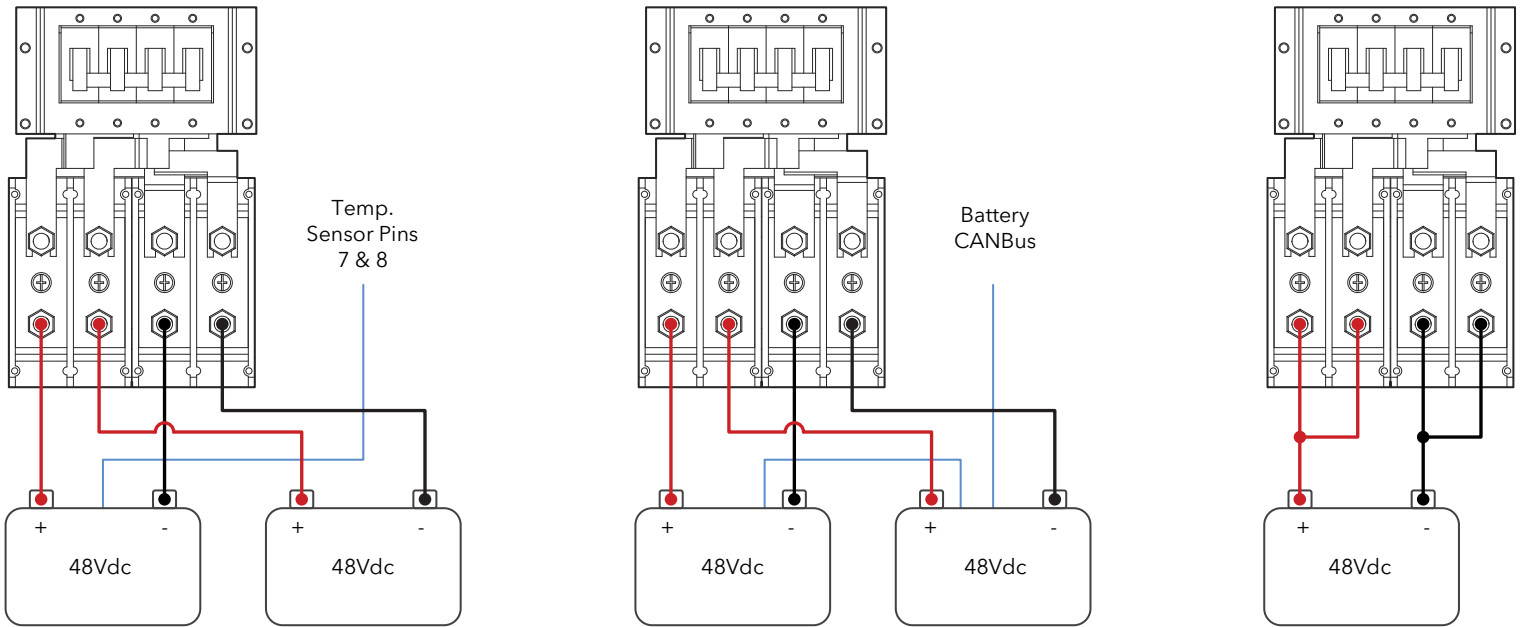

Figure 7: Multi-terminal battery installation

! If a single battery is capable of charging / discharging above 160A, connect the battery to both input terminals. Otherwise, the charge and discharge rate will be limited to 160A max. Connect batteries of the same brand, model, and chemistry to both terminals

## ! IMPORTANT NOTE: Multi-system install

- A. **ALL** parallel inverters **MUST** connect to a single battery bank. The system will **NOT** operate properly if this instruction is not followed.
- B. **DO NOT** use separate battery banks in parallel systems.

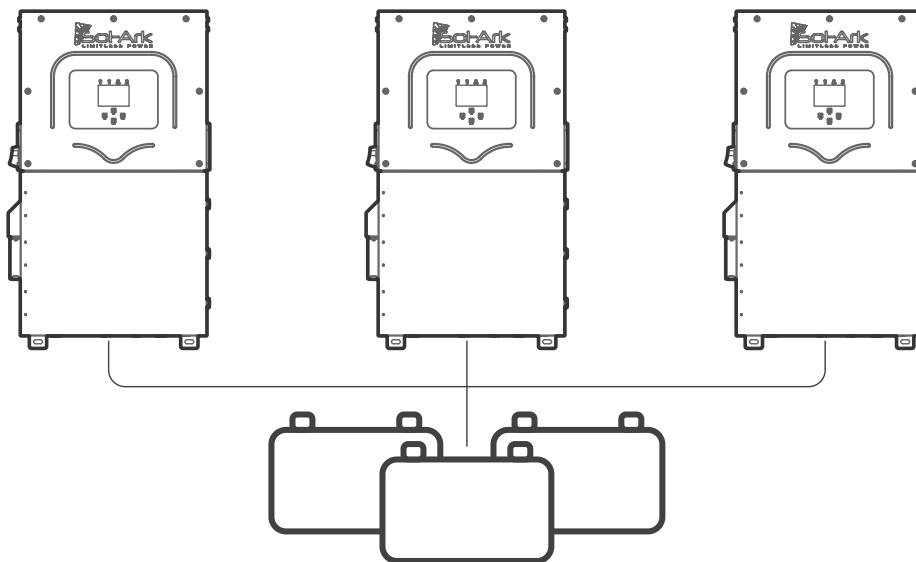

Figure 8: Single battery bank for parallel inverters

## 2.3 Connecting PV Modules

### E.M.P Systems Only - Suppressor Installation

If you purchased your system with Lightning / EMP Hardening, most of the protection is within the Sol-Ark. However, additional EMP suppressors are included to protect home appliances and solar panels. The Sol-Ark 15K-2P-N includes:

- a. Small suppressor amount: 28
- b. Big suppressor amount: 44

Although not critical, their installation is recommended. These suppressors must be installed on the power cord, as close to the appliance as possible. Additionally for solar panels, the big suppressors must clamp both conductors and must be secured with a zip tie. If you purchased the solar panels from us, a >150kV/m protection has already been installed inside the solar panels.

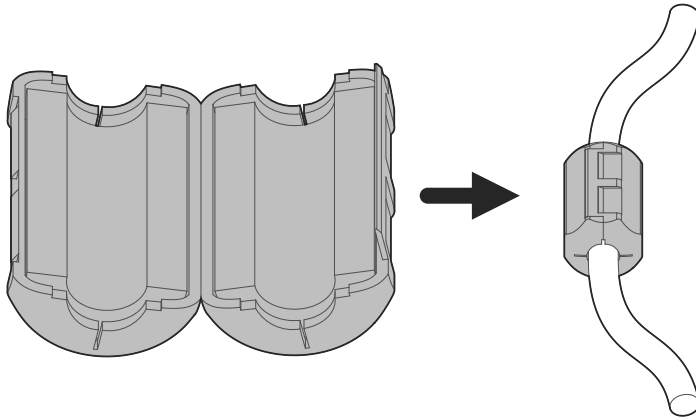

a) Installation of small suppressor on appliance power cord

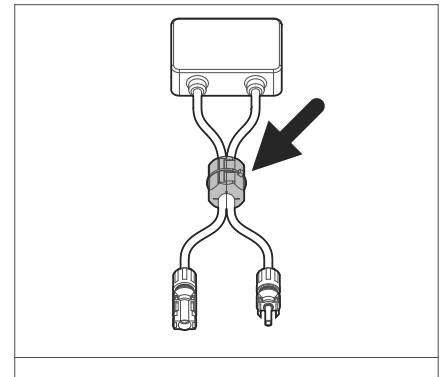

b) If not using panels from Sol-Ark: big suppressor on solar panel

Figure 9: EMP suppressor installation

**!** The inverter has 3 independent MPPTs and each can handle up to 2 PV strings. Each MPPT can operate at a current of 26A (self-limiting) and a MAX Voc of 500V.

- A. Max DC solar input = 19.5 kW (± 5%) | Max input power per MPPT = 6.5 kW | Max input voltage per MPPT = 500 Voc | Max input current per MPPT = 26A (self-limiting).
- B. **⚠ There will be damage if Voc > 500V**
- C. **!** Strings in parallel on the same MPPT must have the same designed open-circuit voltage (Voc), otherwise the system will be limited to the lowest string voltage.
  - i. PV1 A/B must have the same Voc.
  - ii. If the solar panels are oriented in different directions and connected in the same MPPT, there will be a loss in PV efficiency.
- D. **!** It is recommended to ground the mounting frame from the PV array to an **external grounding system**.
- E. **⚠** Design for a max input current of 26A per MPPT. The inverter will self-limit beyond 26A. If current exceeds 30A I<sub>sc</sub> limit, damage will occur.
- F. Connect the solar panel strings using either of the following configurations:

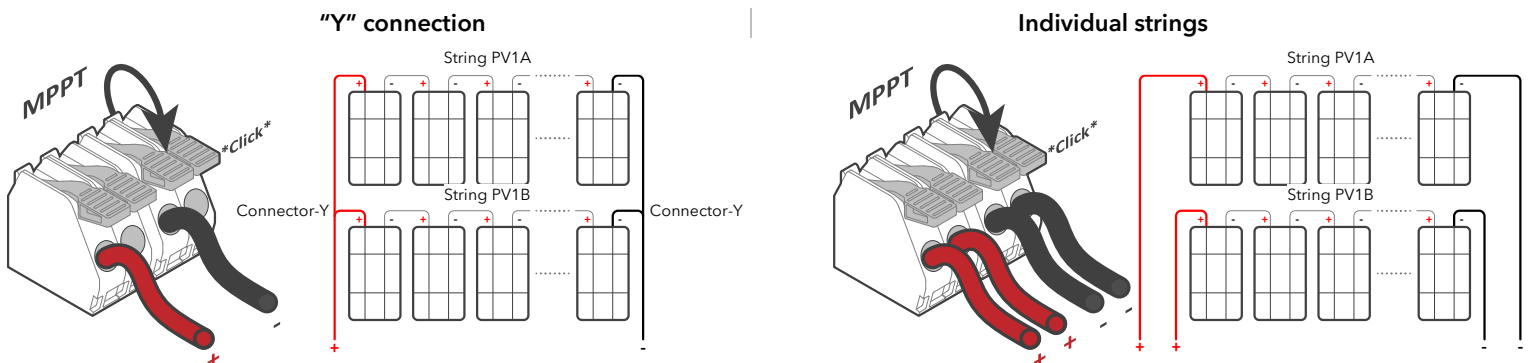

Figure 10: MPPT wiring and PV connections



## AC Coupling

The Sol-Ark 15K-2P-N is a system that supports the addition of AC coupled solar panels. The max solar input power can be expanded by coupling micro or string inverters into the "GEN" or "LOAD" terminals. A full AC coupled solar system is not recommended as power control and monitoring is limited. Having DC coupled modules or a combination of DC coupled and AC coupled solar panels is always preferred.

### 1. AC coupling on "GEN"

- Can produce solar power during a grid outage or Off-Grid systems.
- Can monitor solar production.

### 2. AC coupling on "LOAD"

- Can produce solar power during a grid outage or Off-Grid systems.
- CANNOT** monitor solar production.
-  "GEN" input **CANNOT** be used.
-  Backup Transfer Time is extended to 2 seconds

Max combined solar input (DC+AC) = **38.7kW**  
Total = 19.5 kW<sub>DC</sub> + 19.2 kW<sub>AC</sub>

 In Off-Grid systems, Sol-Ark uses **Frequency Shift** technology to shut down AC coupled solutions when the battery is full. Grid-Tied AC coupled solutions will **always** sell excess solar power back to the grid. "Limited to Load" will **NOT** limit production when AC coupled.

## 2.4 Integrating a Generator

### Generators Smaller than 19.2kW → On "GEN" Terminal

- Supports 120/240V generators only.
- Connect the generator output to the "GEN" input terminal of the Sol-Ark. You must select the correct grid type before connecting the generator.
- A THD (Total Harmonic Distortion) of less than 15% is preferred.
- "GEN" terminal **DOES NOT** support 120/208V 3-Phase generators.

### Generators Bigger than 19.2kW → On "GRID" Terminal

- Supports 220V Single phase, 120/240V Split phase, 120/208V 3-Phase (2 of 3 phases). The correct grid type must be selected before connecting the generator.
- Off-Grid systems with whole-home generators on ATS (Automatic Transfer Switch) or manual transfer switch connected to the "GRID" input, require selecting " GEN Connect to Grid Input".
  - Home Screen** →  → "Limiter" → "Other" → " GEN Connect to Grid Input" → "OK"
- An Off-Grid system should **NOT** use "Grid sell". CT sensors on generator lines are only needed if using "Grid Peak Shaving" to peak-shave the generator.

 **Weekly Gen Exercise:** If a generator has two-wire start compatibility, it will experience weekly generator tests. This test occurs at 8:00AM (local time) every Monday by default. The test takes 20 minutes to complete. The generator will start and stop automatically. The test can be disabled by specifying :00 | 00 min in the "Generator Exercise Cycle Day & Time" option.



## Improve the Generator & Sol-Ark Compatibility

Select **"General Standard"** ("Grid Setup" → "Grid Selection" → "General Standard"), then under the "Connect" tab, increase the frequency range to **"Grid Hz High=65Hz"**, **"Grid Hz Low=55Hz"** to avoid disconnections from the generator. Additionally, increase the voltage range to **"Grid Volt High=275V"** and **"Grid Volt Low=185V"**.

**!** Sol-Ark will not charge the batteries using the generator unless the "Start V" or "Start %" condition is fulfilled. Only one condition (V or %) will be modifiable depending on which control mode is selected ("Use Batt V Charged" or "Use Batt % Charged")

## 2.5 Grid Peak Shaving

- !** To use Peak-Shaving for a generator, it must be connected to the "GRID" terminal.
- Peak-Shaving helps reduce grid consumption during peak demand. Furthermore, it prevents overloads to the generator connected to the "GRID" input.
- Install the CT sensors so that they measure L1 and L2 of the generator / grid input. The arrows on the CTs must point toward the generator / grid.
- Sol-Ark contributes power from the batteries above the programmed **"Power"** threshold.
- This mode will automatically adjust the amperage (A) from "Grid Charge A", to avoid overloads during battery charging.
- !** Grid Peak-Shaving will automatically enable "Time of Use". The "Time of Use" settings must be configured.

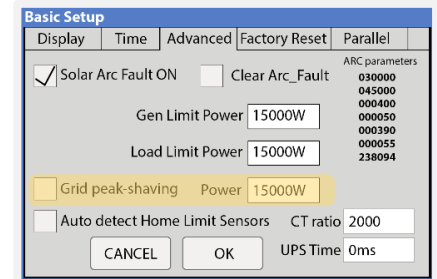

Figure 11: Grid peak-shaving setting

## 2.6 Automatic Generator Start

- "Gen Charge"** is used when the generator is connected to the **"GEN"** input.
  - "Start V" or "Start %"** is the set-point/condition that must be fulfilled to automatically start the generator.
  - To charge the battery from the "GEN" source, "Gen Charge" must be selected.
  - !** Batteries will charge from a generator until the battery bank accepts 5% of its programmed capacity in Amperes (A). This is equivalent to around 95% of the state of charge (SOC).
- "Grid Charge"** is used to charge the battery from the **"GRID"** input source (grid or a generator).
  - "Start V" or "Start %"** is the set-point/condition that must be fulfilled to automatically start the generator and begin charging the battery.
  - To charge the battery from the "GRID" source, **"Grid Charge"** must be selected.
  - !** From grid; the batteries will be charged to 100% from utility grid.
  - !** From generator; the batteries will charge from a generator until the battery bank accepts 5% of its rated capacity in Amperes (A). This is equivalent to around 95% state of charge (SOC).

**!** If **"Time of Use"** ("TOU") is enabled, **"Charge"** must be checked on desired time intervals. Otherwise, the generator won't automatically start even if the Start V or Start % condition has been met.

## Gen Charge / Grid Charge "A"

"A" is how many amps (DC) are supplied to the battery from a generator. Adjusting and limiting the GEN or GRID "A" value will ensure that small generators are not overloaded when charging the battery bank.

If connecting more than one Sol-Ark in parallel, multiply the Gen or Grid "A" value by the **# of Sol-Ark inverters** to get the actual current (A) what will go into the battery bank.

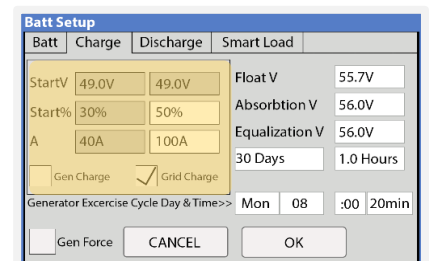

Figure 12: Generator and grid charge settings

## 2.7 Integrating Sensors and Accessories

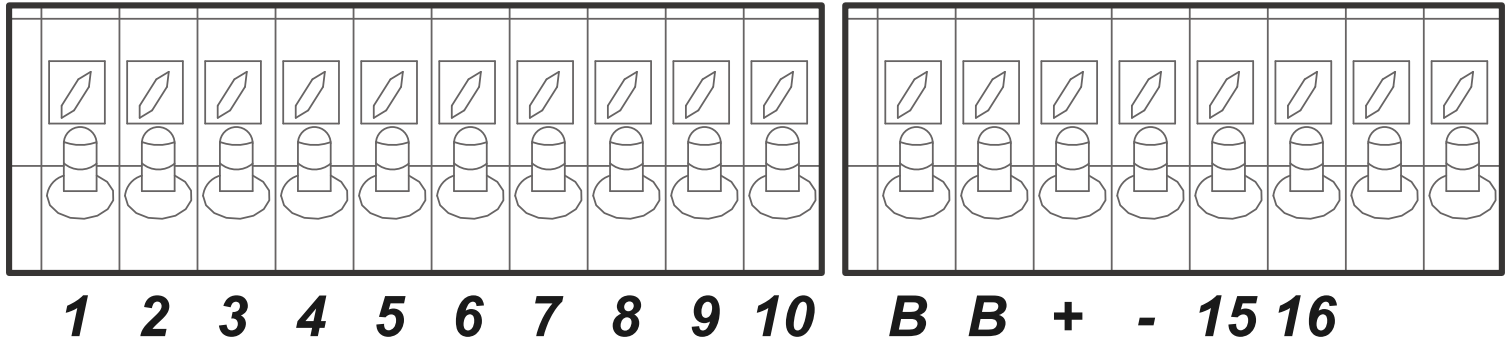

Figure 13: Inverter pinouts for sensors and accessories

- **(1,2) Battery temperature sensor:** Not polarity sensitive. Used for voltage compensation for Lead Acid batteries
- **(+3, -4) CT1 & (+5, -6) CT2:** Current transformer (CT) inputs
- **(7,8) Gen Start Relay:** Normally open relay for generator two-wire start
- **(9,10):** Not in use
- **(B, B) Emergency Stop:** Normally open dry contact for emergency stop
- **(+, -):** Not in use
- **(+15, -16):** 12Vdc (-3%) power supply for RSD transmitters (100mA max, 12Vdc, 1.2W)

### Temperature Sensor

- Place the sensor between two batteries as shown in the next figure.
- Secure with tape and place the sensor away from the batteries terminals to prevent overheating.
- This sensor has no polarity when connecting to the inverter. The temperature sensor helps perform voltage charging adjustments and capacity calculations due to changes in temperature.
- **!** Lithium Batteries **DO NOT** require our external temperature sensor.

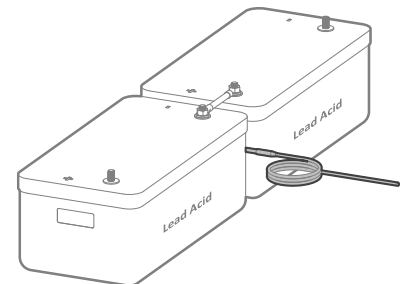

Figure 14: Temperature sensor for Lead-Acid batteries

### BMS Port (CAN/RS485)

- This port is used to setup a Lithium Battery in closed-loop communication with the Sol-Ark 15K-2P-N (consult our **"Battery Communications Integration Guide"** on the Sol-Ark website at [www.sol-ark.com/battery-partners](http://www.sol-ark.com/battery-partners)).
- Must use an RJ45 connector.
- Only use the CAN port for battery BMS communications (the CAN port supports both CANBus protocol and Modbus protocols).

### Wi-Fi / Ethernet Antenna (Dongle)

- Remote monitoring and software updates require an internet connection through the Wi-Fi / Ethernet Antenna (Dongle).
- Compatible with Wi-Fi or Ethernet connections.

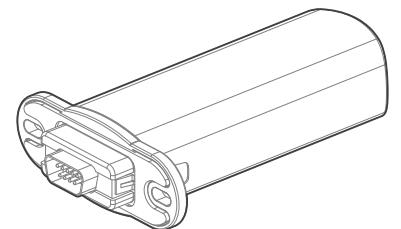

Figure 15: Wi-Fi dongle (antenna)

### GEN Start Signal (Two-wire start)

- The signal comes from a normally open relay that closes when the generator **"Start"** condition is met

## 2.8 Limit Sensors (CT sensors)

The CT sensors (or limit sensors) enable the use and smooth operation of the system work modes known as **“Limited Power to Home”** and **“Grid Peak-Shaving”**. The CTs will measure and calculate the demand in the Main Service Panel which the Sol-Ark 15K-2P-N will then use to accurately supply and offset all home loads.

**!** Off-Grid system do not require CT sensors unless using “Grid Peak-Shaving”

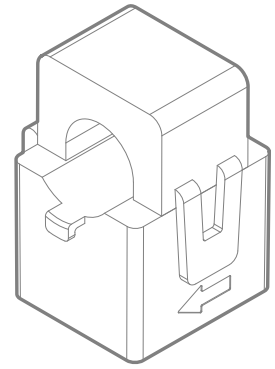

Figure 16: CT Sensor

### CT Sensors Installation

- Install sensors on incoming electrical service wires on L1, L2 and L3 if system is 3-phase.
- Embossed arrows on the sensors must point towards the grid.
- **!** If the system is 120/208V 3-Phase, the arrows must point towards the inverter(s).
- **“Limited Power to Home”** (Meter Zero) and **“Grid Peak Shaving”** require CT sensors.
- To ensure proper fit, check incoming wire diameters (grid or generator). If the sensors are too small, bigger CTs can be purchased by calling sales: +1-972-575-8875 ext. 1 or sales@sol-ark.com
- See section 3.3 “Limiter” for more information about the different work modes.
- See section 7 “Wiring diagrams” for more information on CT installation.

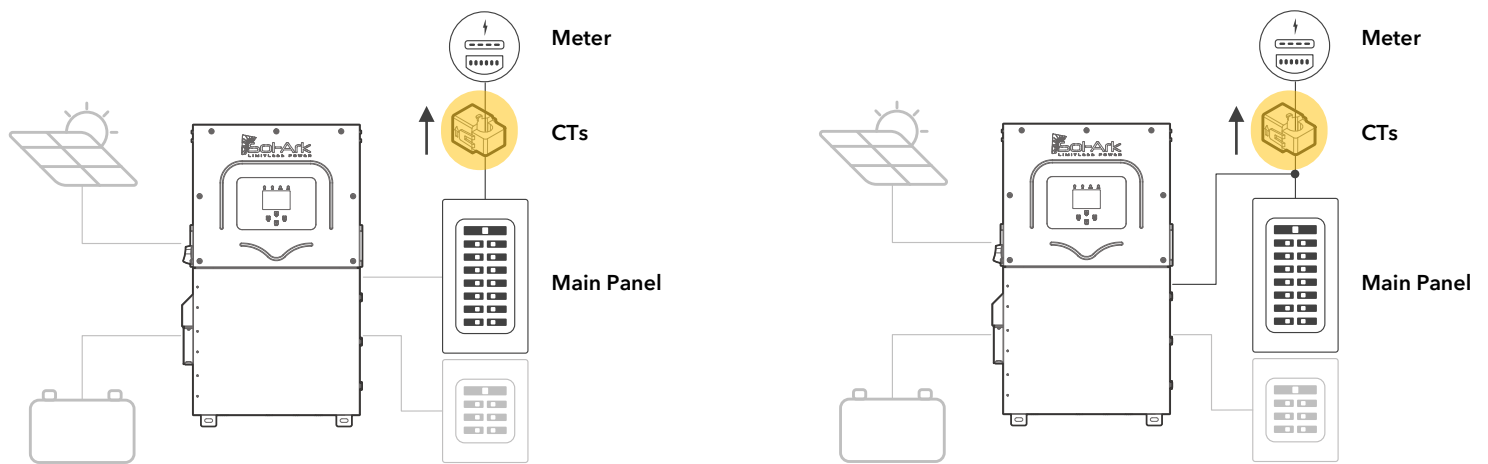

Figure 17: Installation of CTs for a) back-feed breaker and b) line side tap

### CT Sensor Size

- Sol-Ark includes two 1 3/8” CT sensors (300A for 4/0 AWG wire gauge).
- Sol-Ark offers 1 5/16” CTs (200A for 4/0 AWG wire gauge) and 2” CTs (400A) upon request.
- Default Sol-Ark CT ratio is 2000:1

**!** Unless authorized, **DO NOT** change CT Ratio or warranty will be voided

**!** Wire gauge is the only metric used to determine size of CTs. Contact sales at +1 (972) 575-8875 ex.1 to purchase bigger CT sensors

### Wiring the CT sensor

- Connect CT1 from phase L1 to pin 3 (white), 4 (black).
- Connect CT2 from phase L2 to pin 5 (white), 6 (black).
- Keep the wires twisted (white-black) throughout the connection.
- If the wires need to be extended, use CAT 6 (shielded) cable to make an extension (see Figure 19).

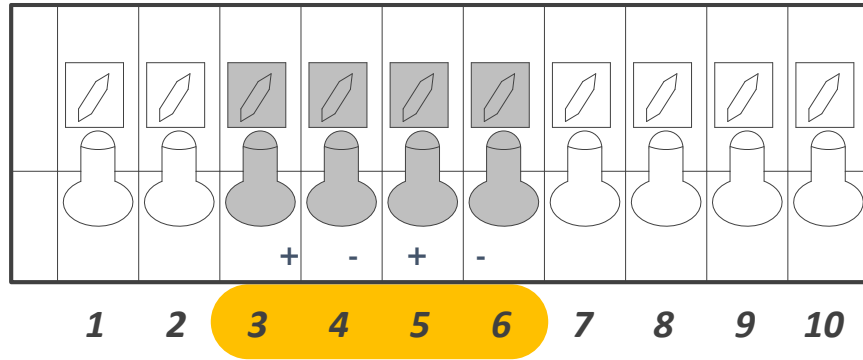

Figure 18: CT input pins on inverter

### CT Sensors for Parallel Systems 120V/240V Split phase

- Each inverter will include two (2) CT sensors.
- Only one pair of CT sensors must be wired to the designated “MASTER” inverter.
- **!** CT sensors are **essential** for multi-Sol-Ark systems as “Limited Power to Home” mode is highly recommended for multi-system installs.

### CT Sensors for Parallel Systems 120V/208V Three-Phase

- Install one CT per phase; connect CT1 to L1 (pin +3, -4) and CT2 on L2 (+5, -6) of inverter 1. Program inverter 1 to be Master, Phase A.
- Install CT3 on L3 (pin +5, -6) of inverter 2. Program inverter to be Master Phase B.
- **!** CT sensors on 3-Phase systems **MUST point in the opposite direction** (i.e., towards the inverters).

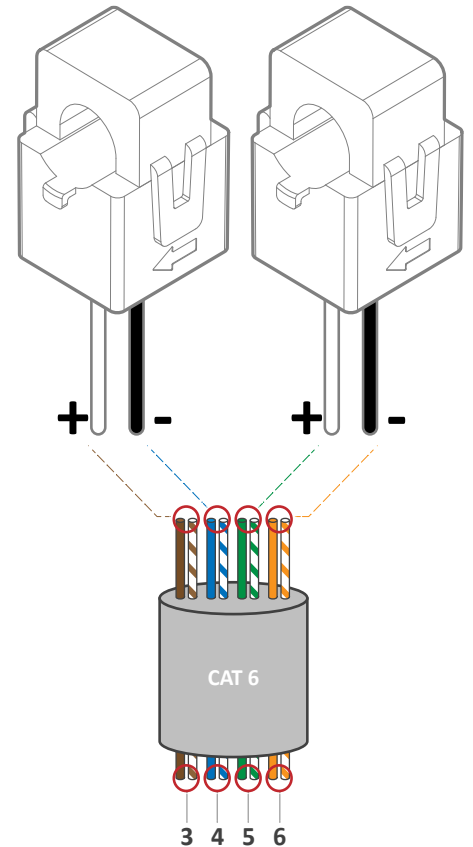

Figure 19: CT wire extensions with shielded CAT 6 cable

### Automatic CT Limit Sensors Configuration

This function **REQUIRES** batteries and 120/240V grid type to auto detect and auto correct CT orientation. AC coupled inverters need to be **OFF** during the detection test. If this test is done with connected AC-coupled systems, a factory reset of the Sol-Ark must be performed. Install the CT sensor as described in section 2.8 “Limit Sensor”. A battery connection and grid power are required before starting the automatic configuration.

⚙️ → **Basic Setup** → **Advanced** →  **Auto detect Home Limit Sensors** → **OK**

Wait at least 10 to 15 seconds while the inverter performs the test. The inverter will alternate the current distribution in all lines, determining the correct orientation of the sensor.

#### **!** CT sensor troubleshooting

- If you are exclusively using “Limited power to Home” (no Grid Sell), HM values will read close to zero (0). Keep in mind that all sensors have a 3% error.
- To avoid selling power to the utility use “Zero Export Power” equal to or greater than 20W.
- Buying power from the grid will display positive (+) HM values, while selling to the grid displays negative (-) HM values.

## 2.9 Emergency Stop and Rapid Shutdown

The (B, B) emergency stop pins of the Sol-Ark 15K-2P-N are a normally open contact that triggers rapid shutdown (RSD) when closed. RSD will cut all power including the Sol-Ark's internal power supply and stop all AC outputs. The internal 12Vdc (-3%) power supply of the Sol-Ark (pins 15 & 16) will disconnect any RSD transmitter that will then shutdown all solar panels when the emergency stop button is pressed.

- Emergency stop button connects to (B, B) pins of the Sol-Ark.
- RSD transmitter connects to pins 15 & 16 (12Vdc power supply).
- **!** For parallel systems: the emergency stop should be connected to the inverter designated as "MASTER" and it will initiate rapid shutdown on all paralleled inverters.

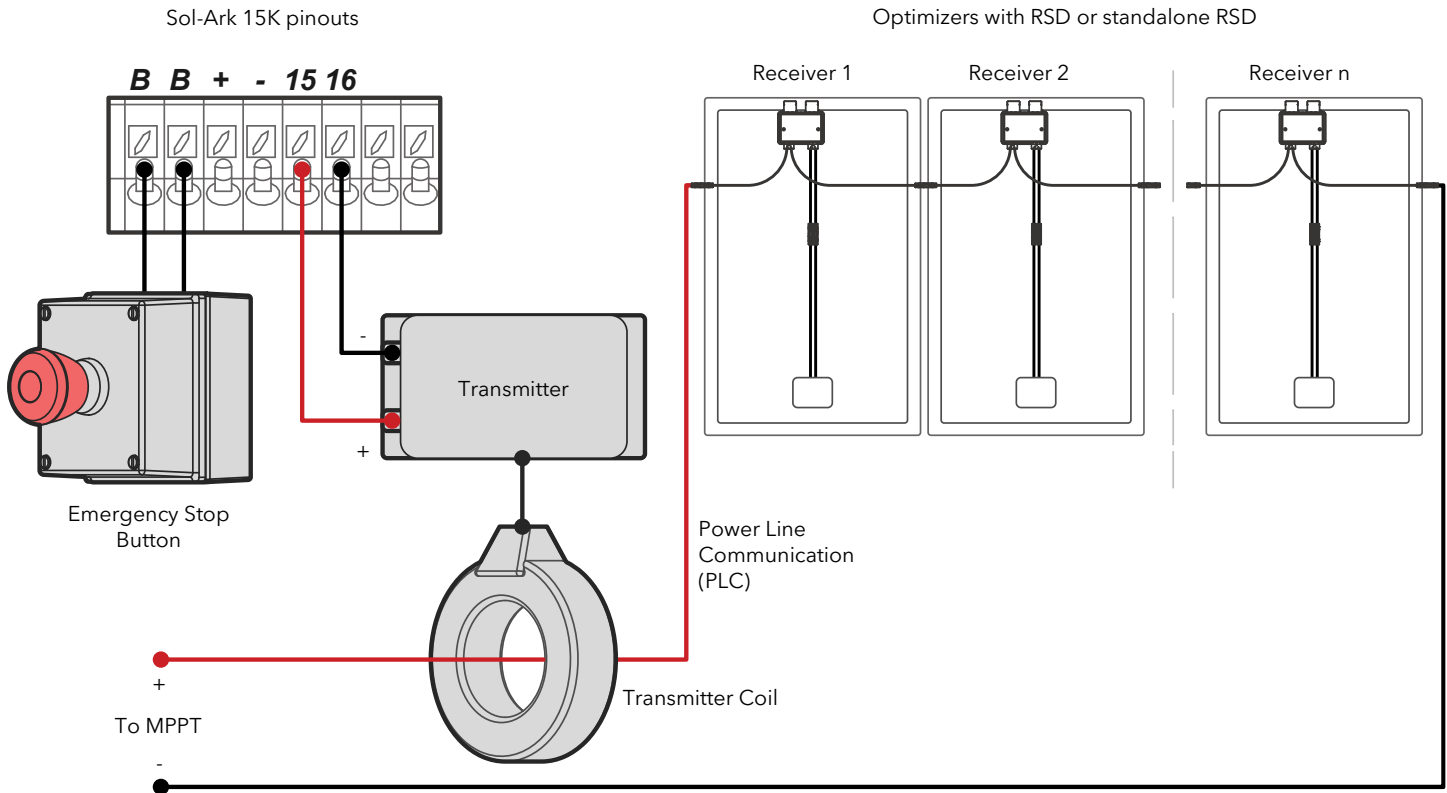

Figure 20: Emergency stop and RSD installation

### **!** RSD Warning

- The Built-in 12Vdc power supply of the Sol-Ark 15K-2P-N (Pins 15 & 16) is rated for **100mA (1.2W)**. Do not exceed!
- If unsure of the current (A) rating of the transmitter, contact the manufacturer before connecting to Pins 15 & 16
- TIGO Optimizers are compatible with the Sol-Ark but **DO NOT** use internal power supply to power the "TIGO Optimizer TX" transmitter

**!** Transmitters placed inside the user area of the Sol-Ark 15K can cause interference

## Rapid Shutdown Recommendations

TIGO TS4-A-O

TIGO TS4-A-F

TIGO TS4-O

TIGO TS4-O-DUO

APsmart RSD S-PLC / RSD-D

## Misc. Hardware Recommendations

**Disconnect / Transfer Switches:** 200A Fused Disconnect: Square D D224NRB Safety Switch Fusible 200A 2P NEMA-3R 240V, Single Throw | Siemens 200 Amp 2-Pole Fusible General-duty Safety Switch Disconnect

**PV Fuses:** 15A PV MC4 in-line fuse holder (ZOOKOTO or DPJ)

**Electrical Panels / Load Centers:** Any appropriately rated panel for your loads.

**Battery Combiners (Parallel Systems Only):** Any appropriately rated pair of Bus Bars with 3/8" battery connection terminals

## 2.10 Powering-up and Testing the Sol-Ark

! TURN ON the inverter with at least one power source: 1) Battery, 2) PV or 3) Grid

### 1. Check the voltage of the battery bank

- ⚠ Voltage of the battery must be between 43Vdc - 63Vdc.
- If applicable, turn **ON** internal switches of the batteries. Measure individual voltages.
- Verify that the voltage of the battery bank at the Sol-Ark terminals is adequate.

### 2. Check the voltage of each PV input circuit

- ⚠ Input voltage must not exceed 500Vdc.
- Input voltage must be above the startup voltage of 125Vdc.
- ⚠ Do not ground PV+ or PV-.
- ⚠ Verify polarity in each PV string. Backward polarity will measure 0Vdc by the Sol-Ark and will cause long term damage.
- ! PV input will only turn on the LCD screen. Inverter requires **grid power** and/or **batteries** to start inverting.
- PV DC disconnect switch on the side of the inverter will turn the PV ON or OFF.

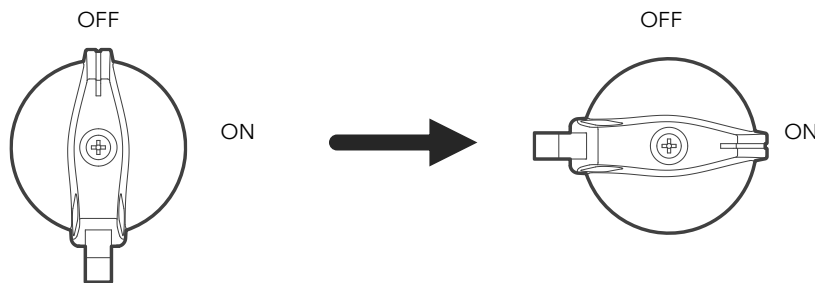

Figure 21: Built-in PV DC disconnect

### 3. Check GRID input voltage

- Use the terminal lugs to measure AC voltages with a multimeter.
- Measure line (L) to neutral (N) voltages on **"GRID"** terminal. Ensure 120Vac on both phases.
- Measure line (L1) to line (L2) voltage on **"GRID"** terminal. Ensure 240Vac. (If voltage reading is close to 220V or 210V, verify if grid is single-phase or three-phase instead).
- Verify that voltage between neutral and ground is 0Vac.
- Verify that voltage between **"GRID" L1** and **"LOAD" L1** is 0V. Do the same for L2.

### 4. Power ON Sol-Ark 15K-2P-N

- Turn **ON** the battery breaker.
- PRESS** down the power button to the **ON** position. Wait for the **"Normal"** LED indicator to turn on. This may take a few minutes.
- Turn **ON** the PV DC disconnect switch. Wait for **"DC"** LED indicator to turn on.
- Turn **ON** the **"GRID"** breaker. Wait for **"AC"** LED indicator to turn on.
- Turn **ON** the **"LOAD"** and **"GEN"** breakers.

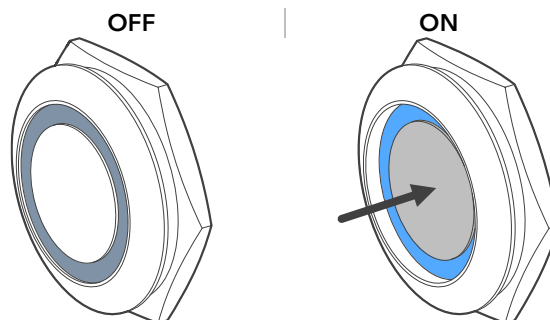

Figure 22: Power Button OFF / ON

## 2.11 Power Cycle Sequence

1. **TURN OFF** all AC breakers (“GRID”, “GEN” and “LOAD”).
2. **TURN OFF** the built-in PV DC disconnect switch on the side of the inverter.
3. **PRESS** the power button, making sure it is in the **OFF** position. An “OFF” message will appear after the “**Normal**” LED turns off.
4. **TURN OFF** the battery breaker.
5. Wait a moment (~1 min) to ensure the inverter is completely de-energized.
6. Make sure that the Sol-Ark is properly connected to the batteries, solar panels, “GRID”, “GEN”, and “LOAD”.
7. Reverse the steps to turn **ON** the Sol-Ark.

## 2.12 LED Indicators

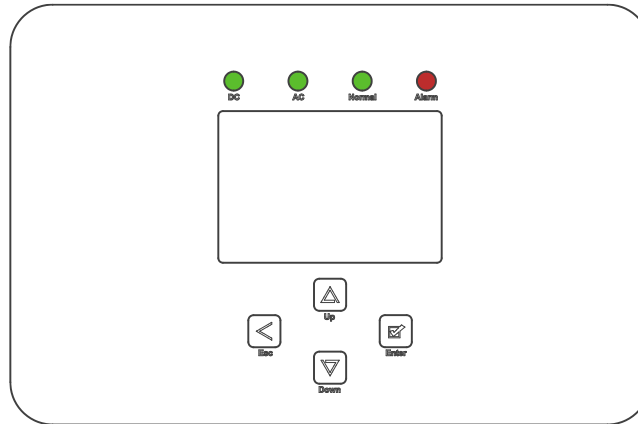

Figure 23: User interface and LED indicators

| DC  | AC  | Normal  | Alarm  |
|---|---|---|--|
| Green → DC Solar Panels connected and providing voltage.<br>OFF → Minimum MPPT voltage not met, wrong polarity or no PV <sub>DC</sub> . | Green → Grid is connected and providing voltage.<br>OFF → Grid voltage out of range or Off-Grid system. | Green → Sol-Ark is <b>fully energized*</b> and inverting power.<br>OFF → Not fully energized*, in fault state or in passthrough mode. | Red → Alarm state. Check the alarms menu. <b>Home Screen</b> → ⚙️ → “ <b>System Alarms</b> ”<br>OFF → No alarms / error codes / setting change notifications |

! \*Fully energizing the unit constitutes at least: a) DC Solar panels **AND** Grid or b) Just batteries

## 2.13 Main screen (Touchscreen)

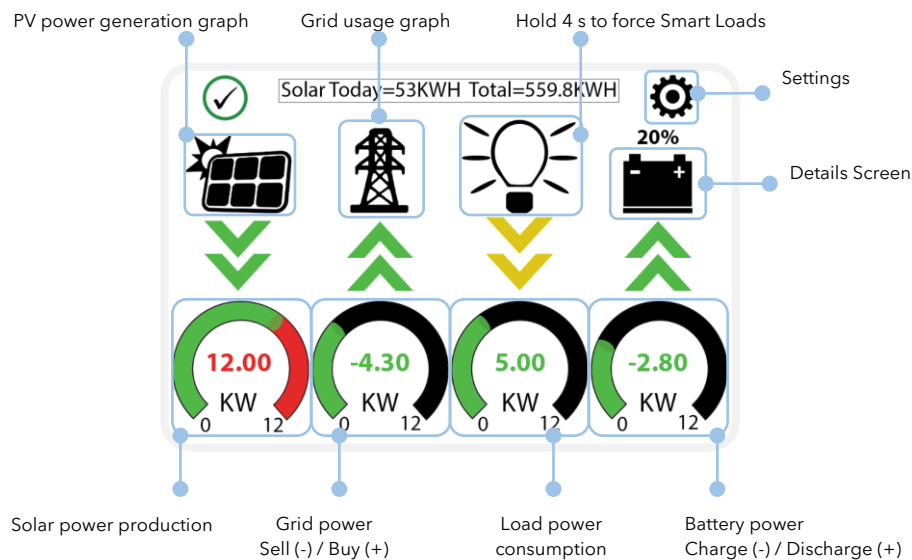

Figure 24: Main Screen

## 1. Details Screen

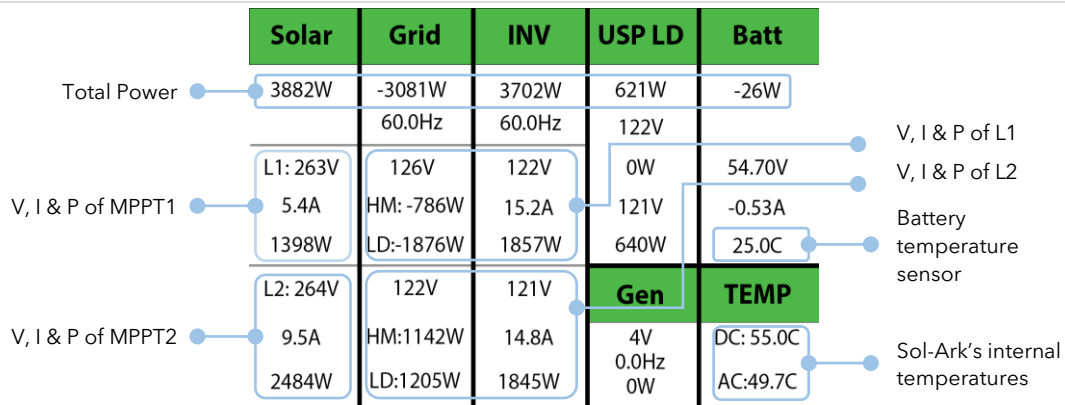

Figure 25: Detail Screen

- ▲ PV voltage from "Solar" column must not exceed 500V.
- Battery temperature will measure 25°C by default if the battery sensor is not connected.
- ! DC Temp: Sol-Ark 15K-2P-N does not have internal DC temperature sensors. Temperature reading can be ignored.
- AC Temp: Internal AC conversion side temperature.
- "Grid" column: power in the grid
  - If selling to the Grid, Watts = negative (-)
  - If buying from the Grid, Watts = positive (+)
  - HM: power detected by the external CTs. L1-L2
  - LD: power detected using internal sensor on "GRID" terminals.

! Opposing "Grid" or "HM" values indicate an incorrect installation of CT. See section 2.8 "Limit Sensor"

## 2. PV power Generation Graph

- Display power production over time for the PV array.
- Use up/down buttons (↑, ↓) to navigate between days.
- Month view/ year view/ total production.

## 3. Grid Usage Graph

- Displays power drawn from grid (+) / sold to the grid (-).
- Values above the line indicate "power bought" from the grid.
- Values below the line indicate "power sold back" to the grid.
- This view can help to determine when the peak power is used from the grid.

## 4. System Setup Menu

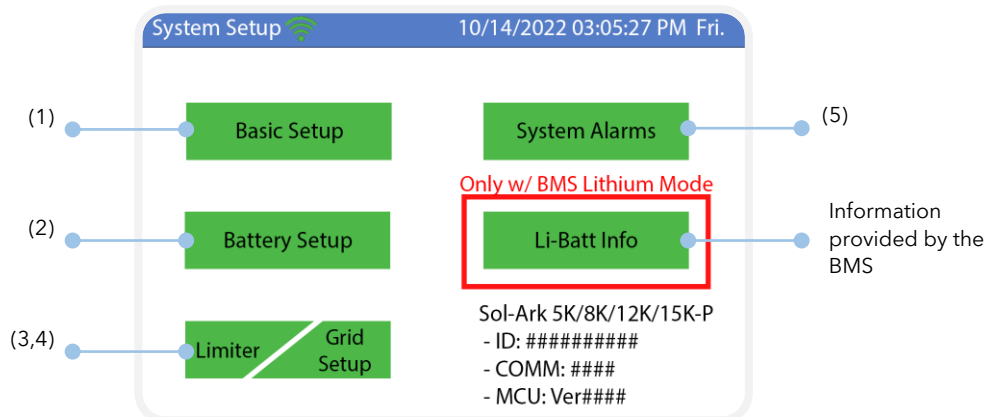

Figure 26: System setup screen



# 3. User Interface

## Main Menu

Solar Today=53KWH Total=559.8KWH

| Solar                     | Grid                            | INV                    | USP LD                          | Batt                                  |
|---------------------------|---------------------------------|------------------------|---------------------------------|---------------------------------------|
| 3882W                     | -3081W<br>60.0Hz                | 3702W<br>60.0Hz        | 621W<br>122V                    | -26V                                  |
| L1: 263V<br>5.4A<br>1398W | 126V<br>HM: -786W<br>LD: -1876W | 122V<br>15.2A<br>1857W | 0W<br>121V<br>640W              | 54.70V<br>-0.53A<br>25.0C             |
| L2: 264V<br>9.5A<br>2484W | 122V<br>HM: 1142W<br>LD: 1205W  | 121V<br>14.8A<br>1845W | <b>Gen</b><br>4V<br>0.0Hz<br>0W | <b>TEMP</b><br>DC: 55.0C<br>AC: 49.7C |

System Setup 10/14/2022 03:05:27 PM Fri.

Basic Setup

Battery Setup

Limiter

System Alarms

Only w/ BMS Lithium Mode

Li-Batt Info

Sol-Ark 5K/8K/12K/15K-P  
- ID: #####  
- COMM: ####  
- MCU: Ver####

System Alarms 1/25/2021 03:05:27 PM Mon.

| Alarms Code           | Occurred         |
|-----------------------|------------------|
| F13 Grid_Mode_changed | 2021-01-13 11:22 |
| F13 Grid_Mode_changed | 2021-01-13 11:20 |

0.00 V 0.00 A 0.0 C 0% 0 Ah

0.0 V 0.0 V 0A 0A 0x00 0x00

Only w/ BMS Lithium Mode

|                           |                 |
|---------------------------|-----------------|
| 1. 0.00V 0.00A 0.0C 0.0%  | 0.0V 0.0A 0 0 0 |
| 2. 0.00V 0.00A 0.0C 0.0%  | 0.0V 0.0A 0 0 0 |
| 3. 0.00V 0.00A 0.0C 0.0%  | 0.0V 0.0A 0 0 0 |
| 4. 0.00V 0.00A 0.0C 0.0%  | 0.0V 0.0A 0 0 0 |
| 5. 0.00V 0.00A 0.0C 0.0%  | 0.0V 0.0A 0 0 0 |
| 6. 0.00V 0.00A 0.0C 0.0%  | 0.0V 0.0A 0 0 0 |
| 7. 0.00V 0.00A 0.0C 0.0%  | 0.0V 0.0A 0 0 0 |
| 8. 0.00V 0.00A 0.0C 0.0%  | 0.0V 0.0A 0 0 0 |
| 9. 0.00V 0.00A 0.0C 0.0%  | 0.0V 0.0A 0 0 0 |
| 10. 0.00V 0.00A 0.0C 0.0% | 0.0V 0.0A 0 0 0 |
| 11. 0.00V 0.00A 0.0C 0.0% | 0.0V 0.0A 0 0 0 |
| 12. 0.00V 0.00A 0.0C 0.0% | 0.0V 0.0A 0 0 0 |
| 13. 0.00V 0.00A 0.0C 0.0% | 0.0V 0.0A 0 0 0 |

## 3.1 Basic Setup

**Basic Setup**

Display Time Advanced Factory Reset Parallel

Brightness   Beep

Auto Dim  600S

CANCEL OK

**Basic Setup**

Display Time Advanced Factory Reset Parallel

AM/PM Year 2021 Month 10 Day 26

Time Sync PM Hour 03 Minute 04 Second 15

Seasons Start M-D Season1 1 - 1 Season2 4 - 1 Season3 8 - 1

End M-D 4 - 1 8 - 1 12 - 1

CANCEL OK

**Basic Setup**

Display Time Advanced Factory Reset Parallel

Solar Arc Fault ON  Clear Arc\_Fault

Gen Limit Power 15000W

Load Limit Power 15000W

Grid peak-shaving Power 15000W

Auto detect Home Limit Sensors CT ratio 2000

UPS Time 0ms

CANCEL OK

**Basic Setup**

Display Time Advanced Factory Reset Parallel

Factory Reset  System selfcheck

Lock out all changes  Test Mode

Lock Grid Charging & Limited

CANCEL OK

**Basic Setup**

Display Time Advanced Factory Reset Parallel

Parallel  Master  Slave Modbus SN 00

Phase A  Phase B  Phase C

Meter > Grid  Meter > Load

Meter Select No Meter

CANCEL OK

### Display

**Brightness:** Brightness adjustment (+, -).

**Auto Dim:** Must be enabled at all times to validate the warranty of the LCD screen.

**Beep:** Enable / disable the alarm sound.

### Time

**Time Sync:** Automatically syncs with the internet for daylight saving time changes (Enabling "Time sync" is recommended).

**Seasons:** Indicate in which seasons TOU will be active.

## Advanced

**Solar Arc Fault ON:** Enables Arc fault detection algorithm on the MPPTs.

**Clear Arc Fault:** Command to clear an Arc Fault. It must be executed manually every time the system detects an F63 Arc\_Fault alarm. See section 8.1 "Sol-Ark Error Codes" for more detail.

**Gen Limit Power:** Sets the Sol-Ark limit to keep the power drawn from the "GEN" terminal below the threshold. The inverter will reduce the charge power rate to the batteries if this value is reached.

**Load Limit Power:** Sets the total AC output power from the batteries to the "LOAD" terminal of the Sol-Ark. The default value is always the maximum output of the inverter production.

**Grid-Peak Shaving:** Sets the Sol-Ark's threshold to begin contributing power from batteries to keep the power drawn from the grid of generator connected to the "GRID" terminal, below that value.

**Auto detect home Limit Sensor:** Detects and auto-corrects the polarity of the current transformers (CT sensors).

**CT Ratio:** Ratio from CT sensor input/output, the default value is 2000:1. **DO NOT** change this value or you will void the inverter warranty.

**UPS Time:** Backup transfer time when there is a grid loss. 5ms for lowest transfer time.

## Factory reset

**Restrictions:** Changes to these settings must be previously authorized by Sol-Ark technical support agents.

## Parallel

**Parallel:** Enable whenever you have more than one system connected. "Master" and "Slave".

**MODBUS SN:** Identification number for each system configured in parallel (1,2,3,4, n).

**Phase:** When dealing with a 120/208V 3-Phase system, there must have a "Master" unit responsible of their own phase A, B and C.

See section 5 "Parallel Systems" for more information

## 3.2 Battery Setup

The image displays four screenshots of the Sol-Ark Battery Setup interface, organized into four panels:

- Top Left Panel:** Shows settings for Batt Capacity (400Ah), Max A Charge (275A), Max A Discharge (275A), and TEMPCO (-0mV/C/Cell). It includes checkboxes for "Use Batt V Charged", "Use Batt % Charged", "No Battery", "BMS Lithium Batt", and "Activate Battery".
- Top Middle Panel:** Shows StartV (49.0V), Start% (30%), A (40A), Float V (55.7V), Absorption V (56.0V), Equalization V (56.0V), and 30 Days (1.0 Hours). It also includes "Gen Charge", "Grid Charge", and "Generator Exercise Cycle Day & Time" (Mon 08 :00 20min).
- Top Right Panel:** Shows Shutdown (46.0V, 20%), Low Batt (47.5V, 35%), Restart (52.0V, 50%), Batt Empty V (47.0V), Batt Resistance (8mOhms), and Batt Charge Efficiency (99.0%).
- Bottom Panel:** Shows "Use gen input as load output", "On Grid always on", "Smart Load OFF Batt" (51.0V, 80%), "Smart Load ON Batt" (54.0V, 90%), and "Solar Power(W)" (500W).

## Batt

**Batt Capacity:** Battery charge capacity connected to the system; value expressed in Amp Hour (Ah).

Batteries in series → Voltage adds up (V).

Batteries in parallel → Capacity adds up (Ah).

**Max A Charge:** Sets the Max Charge rate of the batteries from solar panels. 275A max

Rule of thumb for Lead-Acid batteries: If manufacturer does not specify rated charge amps, use 20% - 30% of battery capacity as Max A Charge.

**Max A Discharge:** Sets the Max Discharge rate for battery. 275A max.

For Off-Grid systems, the battery bank will discharge 120% of this value for a 10 second surge before the inverter faults to prevent battery damage.

**TEMPCO:** Temperature coefficient used in conjunction with the battery temperature sensor to adjust optimal voltages for lead-acid batteries.  Lithium batteries do not require a TEMPCO setting (-0 mV/C/Cell).

**Use Batt V Charged:** Displays battery charge in terms of voltage.

**Use Batt % Charged:** Displays battery charge in terms of %. The inverter uses algorithms that measure power in and out to estimate a true value for state-of-charge %. It compensates for aging batteries.

**No Battery:** “No Battery” option **MUST** be selected if there is no battery present. A power cycle sequence is **REQUIRED** when selecting this option. (Refer to section 2.11 for power cycle instructions).

**BMS Lithium Batt:** Allows closed-loop communication with our tested batteries included in our “Battery Integration Guide”. (Refer to [www.sol-ark.com/battery-partners](http://www.sol-ark.com/battery-partners))

**Activate Battery:** This option **MUST** be selected if the system has batteries, especially with **Lithium** batteries.

## Charge

**Float V:** Lower steady voltage at which the battery is maintained after being fully charged.

**Absorption V:** Constant voltage used to charge the battery.

- Absorption will stop at 98% of the capacity of the battery bank and then drop to the Float setpoint.
- Example: A 400Ah battery will stop charge reaching 392Ah.

**Equalization V:** Voltage that the system uses to generate a calculated overcharge, utilizing a higher voltage or equal to the absorption to remove the generation of sulfates in batteries. Used to balance internal cells.  Most Lithium batteries do not need to equalize.

**Days:** The period between equalization cycles.

**Hours:** The period taken to equalize batteries.

-  If “Hours” is set to 0 hours, the system will not equalize batteries.

**Gen Charge:** Uses the “GEN” input of the system to charge the battery bank from a generator.

- Start V:** Voltage at which the system will AutoStart a generator to charge the battery.
- Start %:** Percentage S.O.C (state of charge) at which the system will AutoStart a generator to charge the battery.
- A:** Maximum rate of charge of the batteries from the generator (DC amps).

**Grid Charge:** There are two scenarios in which this option is used:

- Grid connected to “Grid” input:** The inverter will limit the charge rate to the set value in “A” and the battery will charge to 100% SOC.
- Generator connected to “Grid” input:** It will be necessary to select “ GEN connect to Grid input”. The system will use “Start V”, “Start%” and “A” conditions to charge the battery and stop charging at 95% SOC ( Adjustable upper limit if Time of Use is enabled).

**Gen Exercise Cycle (Day & Time):** Set a weekly generator exercise schedule. (Day of the week/time/duration length).

**Gen Force:** Forces the relay close for the generator two-wire start.



*The generator must be in automatic mode if applicable and must have a two-wire start (dry-contact, normally open) connected to the Sol-Ark. To disable the Gen exercise, adjust the time duration to 0 min.*

## Discharge

**Shutdown:** Battery voltage or % at which the inverter will shut down to protect the battery from an over discharge situation (battery symbol on the home screen will turn red).

**Low Batt:** Low battery voltage or % (battery symbol on the home screen will turn yellow). Stopping point for TOU.

**Restart:** Battery voltage or % at which AC output will resume conversion DC to AC after reaching “shutdown” voltage.

**Batt Resistance:** Internal resistance in mOhms of the battery bank. Used in % SOC batt calculations.

**Batt Charge Efficiency:** Value provided by battery manufacturer. Used in % SOC batt calculations.

**Batt Empty V:** Sets the empty voltage and associates this voltage to 0% charge. This value determines the lowest % SOC limit.

## Smart Load

- This mode uses the “GEN” input as a load output that delivers power when the battery exceeds a user programmable threshold or when the unit is connected to the grid.
- When “ Use gen input as load output” is enabled, the “GEN” terminal turns into an output to power high-power loads such as a water heater, irrigation pump, AC unit, pool pump, or any other loads.
- When “ On Grid always on” is enabled, the “GEN” terminal will always output power as long as the grid is connected, regardless of battery charge.

**Smart Load OFF Batt:** Battery voltage or % at which the “GEN” terminal will stop outputting power.

**Smart Load ON Batt:** Battery voltage or % at which the “GEN” terminal will start outputting power.

**Solar Power (W):** Amount of PV production needed before “GEN” terminal starts outputting power.

**⚠** GEN terminal is limited to 80A at 240V Off-Grid. (Do NOT exceed!)

## AC Coupling Settings - (For AC Coupled Input)

- A. **!** AC coupled PV arrays must have " **Grid Sell**" enabled while the grid is available.
- B. To use the "GEN" or "LOAD" input terminal as an AC-coupled input for micro inverters or grid-tied string inverters, check the appropriate box according to your connection: " **For AC Coupled Input to Gen**" or " **AC couple on load side**".
- C. The meaning of "Smart Load OFF Batt" and "Smart Load ON Batt" change in this mode.

**Smart Load OFF Batt:** The % SOC at which the AC-coupled inverter(s) are shut down when in off-grid mode.

**!** 90% recommended.

**Smart Load ON Batt:** The % SOC at which the AC coupled inverter(s) are turned on when in off-grid mode.

**!** 80% recommended.

To use the "LOAD" terminal for AC coupling microinverters or grid-tied string inverters:

- a. Must select "AC couple on load side".
- b. **⚠** The GEN terminal cannot be used (even though the "GEN" terminal is not physically being used for this mode, AC coupling on the "LOAD" terminal prevents the use of the "GEN" terminals for any other purpose).
- c. Wire as shown in diagram labeled "AC Coupling in LOAD".
- d. **!** Backup Transfer Time is extended to 2 seconds

## 3.3 Limiter

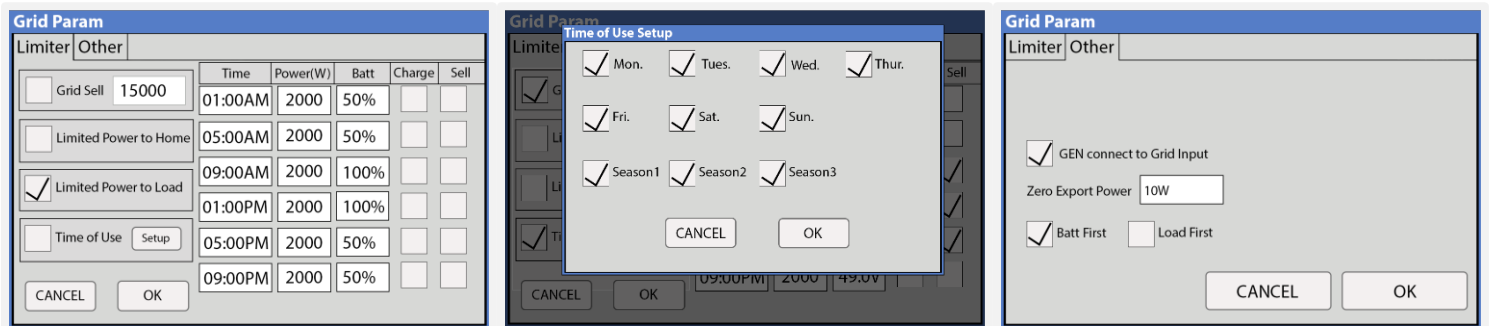

### Limiter

The Sol-Ark 15K-2P-N inverter will simultaneously utilize different available power sources to satisfy load demand in the electrical service panels (essential loads panel / main service panel). The following work modes allow the user to determine how generated power is utilized.

### Grid Sell

**Grid Sell:** The inverter will produce as much power as it has available from PV array according to the programming. The maximum power that can be sold to the grid will be 15,000W.

General description:

- a. This mode allows your inverter to sell back to the grid all the excess power generated from the PV arrays without limitation.
- b. The inverter will only show loads connected to the "LOAD" terminal.
- c. The inverter will measure all power in / out of the "GRID" terminal as grid consumption or grid sell back.

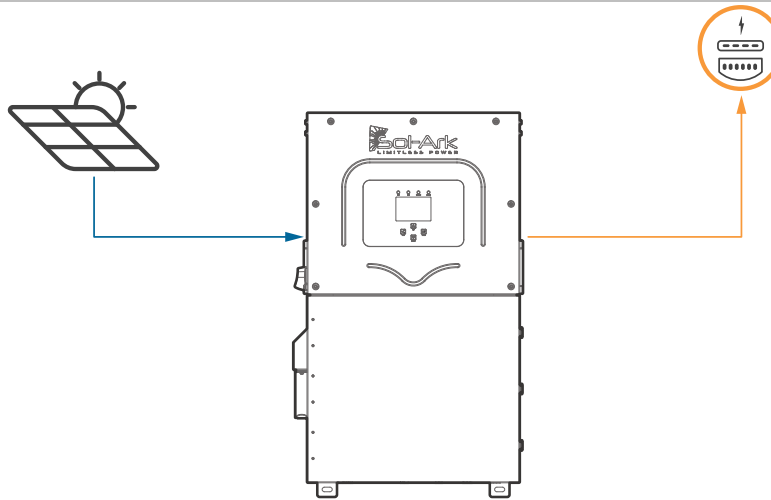

Figure 27: Grid Sell

## Limited Power to Home

! This work mode **REQUIRES** batteries

**Limited Power to Home (Meter Zero):** This mode limits the energy being produced by the inverter to satisfy the home load demand (essential load panel + main service panel). In this mode, the inverter delivers power to the “LOAD” terminal (essential loads panel) + the “GRID” terminal (main service panel). To prevent grid sell back when powering the main service panel, the CT sensors **MUST** be installed. These sensors allow the inverter to calculate the loads in the main service panel wired to the “GRID” terminal. This system work mode is useful for users that don’t have a permit to sell back. See section 2.8 “Limit Sensors” for proper external CT installation.

General description:

- Power is delivered to the whole home without selling the excess solar back to the grid (required if no permit to sell back from the utility company).
- External CT sensors **required** for proper operation of this system work mode.
- Monitored loads will be the addition of the main service panel + essential loads panel.
- Energy Priority:** 1. Solar PV Power | 2. Grid Power | 3. Batteries | 4. Generator

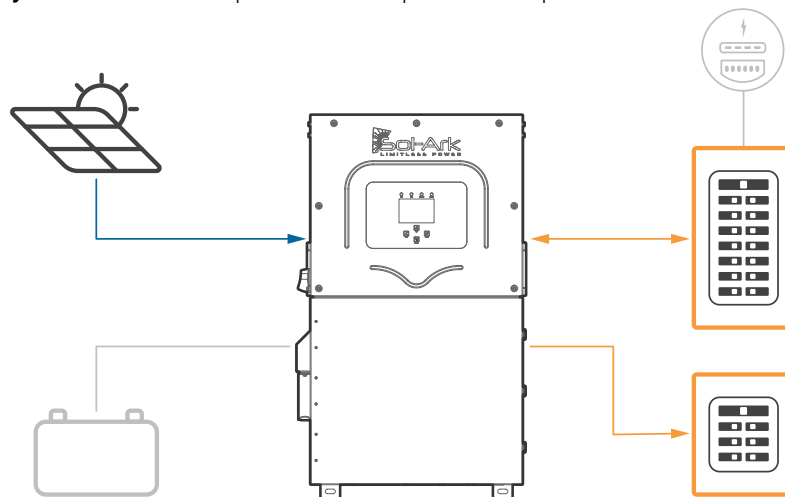

Figure 28: Limited Power to Home

! This work mode is **HIGHLY RECOMMENDED** for parallel systems. “Limited Power to Home” allows optimal power distribution between inverters.

**Limited Power to Home + Grid Sell:** This mode will NOT limit solar production. In this mode, the inverter delivers power to the “LOAD” terminal (essential loads panel) + unlimited power to the “GRID” terminal (main service panel AND grid). The Sol-Ark will monitor grid sell back and load consumption simultaneously (with +/- 3% error from CT sensors). The CT sensors **MUST** be installed. See section 2.8 “Limit Sensors” for proper external CT placement.

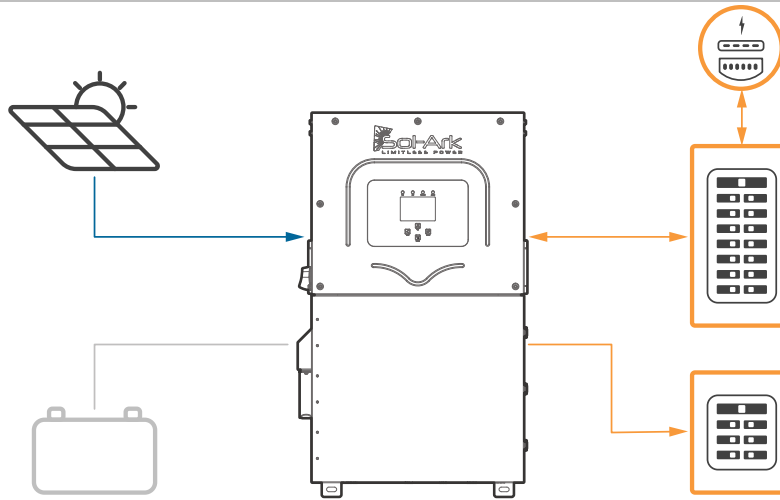

Figure 29: Limited Power to Home + Grid Sell

## Limited Power to Load

! This work mode **REQUIRES** batteries

**Limited Power to Load:** This mode limits the solar production to cover the load demand of the “LOAD” terminal (essential loads panel). In this system work mode, the system disregards the loads in the main service panel and will not deliver power to the “GRID” terminal.

General description:

- The inverter will only cover the loads connected to the “LOAD” terminal.
- It will **NOT** produce more power than the load demand.
- This work mode will **NOT** deliver power to the “GRID” terminal (will NOT sell back).
- The loads reported by the inverter will only be from the essential loads panel (“LOAD” terminal).
- This system work mode is recommended for off-grid applications.
- Energy Priority:** 1. Solar PV Power | 2. Grid Power | 3. Batteries | 4. Generator

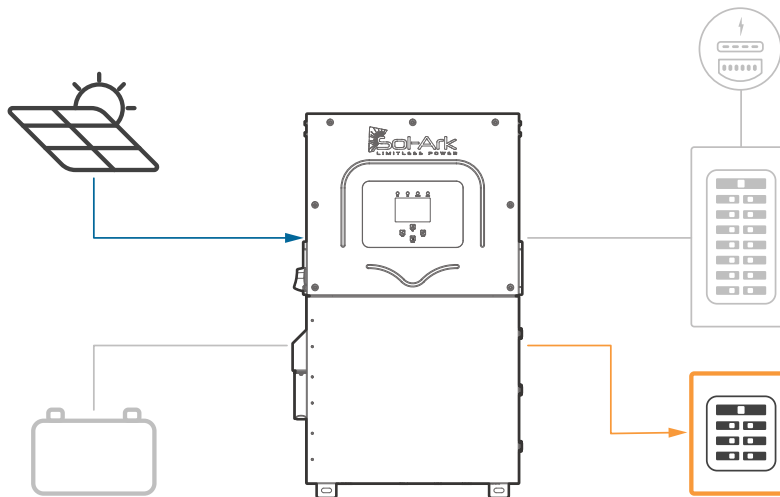

Figure 30: Limited Power to Load

**Limited to Load + Grid Sell:** This mode will NOT limit solar production. The inverter delivers power to the “LOAD” terminal (essential loads panel) + unlimited power to the “GRID” terminal (main service panel AND grid), however it will ONLY track the loads connected to the “LOAD” terminal, but it will sell back excess solar. If there is a main service panel in the “GRID” terminal, the inverter will NOT be able to measure the true value of the total home consumption and grid sell back. This system work mode is recommended for single inverter or for whole home backup installations.

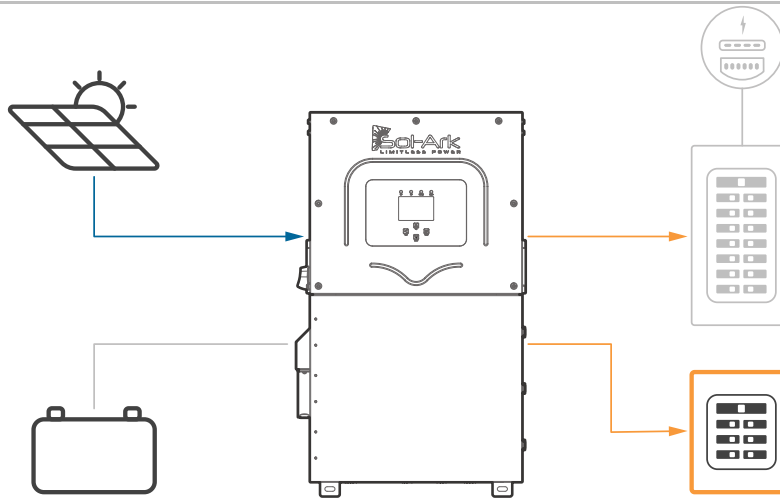

Figure 31: Limited Power to Load + Grid Sell

## Time of Use

**Time Of Use (TOU):** Using this mode, combined with “Limited Power to Home” or “Limited Power to Load”, allows the inverter to discharge the batteries to deliver power to the home and reduce the power consumption from the grid during specific time intervals. The battery discharge will cover the calculated load demand with the threshold discharge power rate set in the “Power(W)” column. You can configure six different discharge rates (Watts) and depth of discharge from the battery (V or %).

General description:

- Uses batteries to reduce the power consumption during user defined periods.
- Energy Priority:** 1. Solar PV Power | 2. Batteries (down to programmed discharge V or %) | 3. Grid Power | 4. Generator.

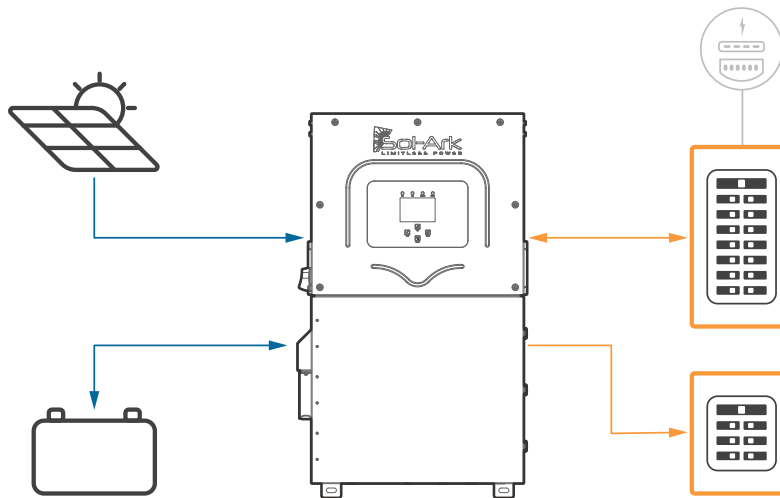

Figure 32: Limited Power to Home + TOU

**Time:** During these hours the system will provide power from the battery to the home or even the grid if desired. The 6-time intervals **MUST** follow a chronological order. All time intervals are automatically enabled.

**Power(W):** This is the maximum discharge power the Sol-Ark will draw from the battery during the time intervals.

**Batt:** Voltage or percentage battery state-of-charge at which the system stops discharging batteries. If  **Charge** is checked, the “Batt” V / % setpoint will change its meaning and it will now be the upper limit at which the inverter charges the battery up to with an AC power source (grid or generator).

**Charge:** Allows the batteries to charge from an external AC power source, such as a generator or grid, during the hours selected, up to the programmed voltage or %. If the external AC power source is a generator, it is also necessary to meet the condition “Start V” or “Start %” located in the Battery Setup to begin charge from a generator. The PV array will always charge the batteries at 100% regardless of the  **Charge** box in TOU.

**Sell:** The  **Sell** box in TOU allows batteries to discharge and sell power to the grid at a constant programmable rate for the selected period, determined by “Power(W)”.  **Grid Sell** must also be enabled.

**!** Do **NOT** enable “Charge” and “Sell” at the same time

## Other

**GEN Connect to Grid Input:** Enable this option if you have a generator connected to the “GRID” terminal.

**Zero Export Power:** Minimum power imported from the grid. Helps avoid selling back to the grid by ensuring constant grid consumption. The value can be set between 1 - 100W (recommended 20W).

**Batt First:** Set the charge priority for the system, the solar PV power will be delivered first to charge the battery (it is recommended to check “Batt First” as it is the most efficient option).

**Load First:** Set the charge priority for the system, the solar PV power will be delivered to cover the loads consumption first, then the remaining will charge the battery. Only recommended for very specific situations.

## 3.4 Grid Setup

The image displays six screenshots of the 'Grid Param' configuration menu, organized into two rows of three. Each screenshot shows a different tab of the configuration interface.

- Top Left:** 'Grid Param' menu with tabs for Grid Selection, Connect, IP, F(W), V(W)/V(Q), and P(Q)/P(F). The 'Grid Selection' tab is active, showing 'Grid Mode' (UL1741SB), 'Grid Reconnect Time' (300s), 'Power Factor' (1.000), 'Fixed Q' (0%), 'Q\_Response' (10s), 'Output V' (120/208V), and 'Output V+' (+0V). Grid frequency options (50Hz, 60Hz) and phase options (Single Phase, 120/240V Split Phase, 120/208V 3 Phase) are also visible.
- Top Middle:** 'Grid Param' menu with 'Reconnect' and 'Normal connect' tabs. The 'Reconnect' tab shows 'Grid Vol High' (228.6V), 'Grid Vol Low' (183.2V), 'Grid Hz High' (61.5Hz), and 'Grid Hz Low' (58.5Hz). The 'Normal connect' tab shows 'Grid Vol High' (249.6V), 'Grid Vol Low' (104.0V), 'Grid Hz High' (62.0Hz), and 'Grid Hz Low' (57.0Hz). Ramp rates are set to 60s.
- Top Right:** 'Grid Param' menu with 'Over Voltage U>(10 min. running mean)' (239.2V) and a table of voltage and frequency limits for HV3, HV2, HV1, LV3, LV2, LV1, HF3, HF2, HF1, LF3, LF2, and LF1.
- Bottom Left:** 'Grid Param' menu with 'Over frequency' and 'Under frequency' tabs. The 'Over frequency' tab shows 'Droop F' (40%PE/Hz), 'Start freq F' (60.50Hz), and 'Start delay' (0.00s). The 'Under frequency' tab shows 'Droop F>' (40%PE/Hz), 'Start freq F>' (59.50Hz), and 'Start delay F>' (0.00s).
- Bottom Middle:** 'Grid Param' menu with 'V(W)' and 'V(Q)' tabs. The 'V(W)' tab shows 'Response\_T' (P1:100%, V1:109.0%, V2:110.0%, V3:111.0%, V4:112.0%) and 'Lin/Lout' (Lin:20.0%, Lout:5.0%, V1:90.0%, Q1:43%, V2:94.0%, Q2:0%, V3:106.0%, Q3:0%, V4:110.0%, Q4:-43%).
- Bottom Right:** 'Grid Param' menu with 'P(Q)' and 'P(F)' tabs. The 'P(Q)' tab shows 'P1:20%', 'P2:100%', 'P3:100%', 'P4:100%' and 'Q1:20%', 'Q2:20%', 'Q3:20%', 'Q4:20%'. The 'P(F)' tab shows 'Lin:50.0%', 'Lout:100.0%', 'V1:50%', 'F1:1.000', 'V2:100%', 'F2:0.800', 'V3:100%', 'F3:0.800', 'V4:100%', 'F4:0.800'.

## Grid Selection

**General Standard:** Allows more flexible adjustments to the grid parameters, such as widening frequencies and voltages to keep the inverter connected to the grid (useful for off-grid systems with backup generators)

**UL 1741 & IEEE1547:** Enables sell compliant functionality.

**UL1741SB:** Enables F(W), voltage, and power factor control to sell back to utility and expands compatibilities. Useful for AC coupled inverters. Expands grid compliances.

**Grid Frequency:** Frequency of the AC sine wave.

**Grid Type:** Three different grid type options; 220V Single Phase, 120/240V Split-Phase and 120/208V 3-phase.

**Grid Reconnect Time:** The amount of time, in seconds, the inverter will wait before reconnecting to the grid.

**Power Factor:** The power factor can be adjusted from ±0.9 to 1.0 (Call technical support if you need to modify this value).

## Connect

**Normal connect:** Protect parameters for the grid. This can only be used with “General Standard”. The voltages shown in this menu correspond to L-L voltage (Maximum voltage difference between lines of +/- 10V before disconnection).

**Reconnect:** Protect parameters for the grid after a grid disconnect. This can only be used with “General Standard”. The voltages shown in this menu corresponds to L-L voltage (Maximum voltage difference between lines of +/- 10V before disconnection).



# 3.5 Programming Guide

The next diagram shows the most used/common parameters for programming the unit Sol-Ark 15K-2P-N.

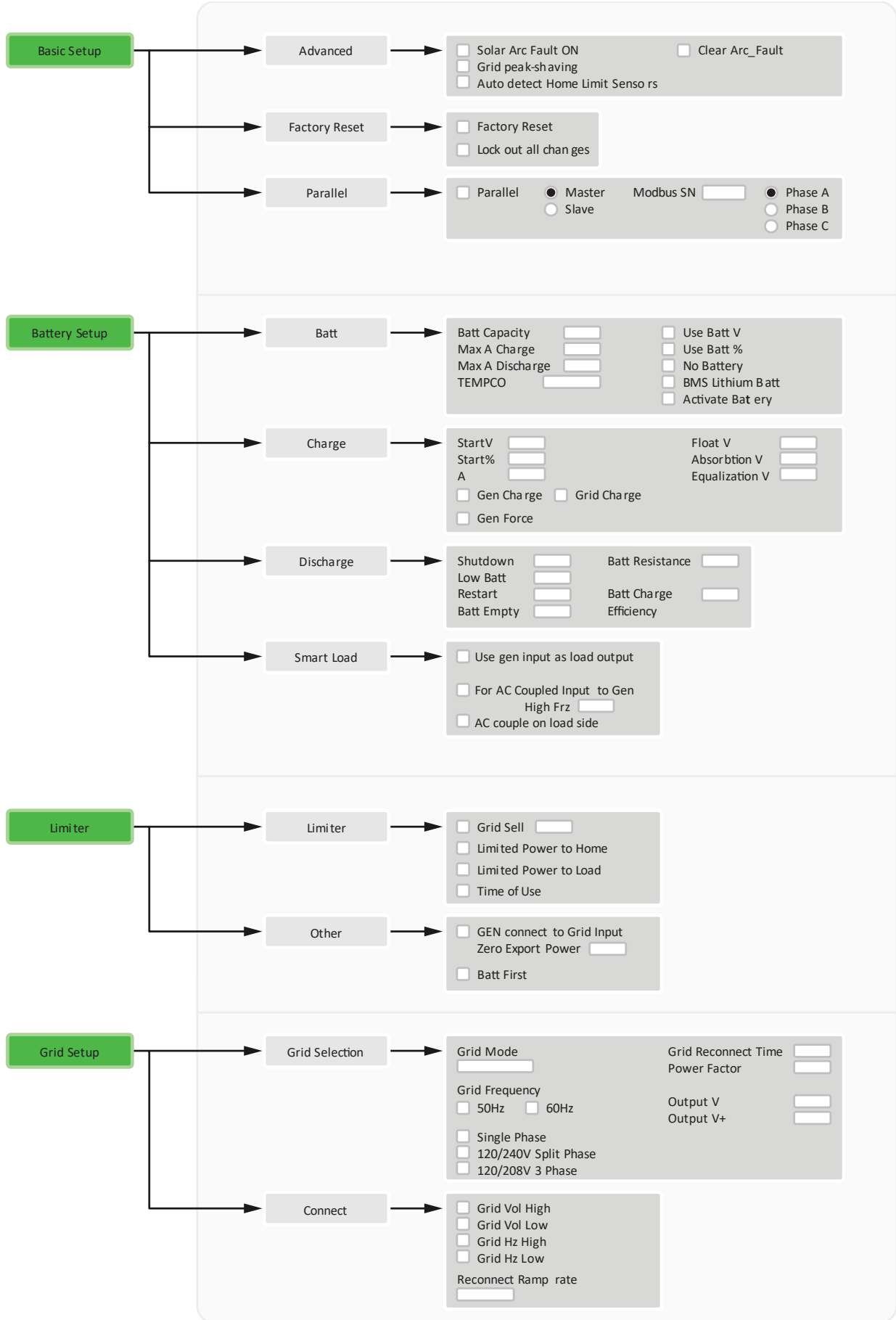

## 4. Installation Tips

### Off-Grid Installation Tips

1. Limit sensors (CTs) are not required for completely off-grid installations unless using **"Grid Peak Shaving"** with a generator connected to the **"GRID"** input terminal.
2. It is recommended for generators to be connected to the **"GRID"** terminal so that the **"Smart Load"** function of the **"GEN"** terminal can be used.
3. There is no need for a transfer switch. Connect the **"LOAD"** output of the Sol-Ark to the main panel.
4. Do not use **"Grid Sell"** mode when Off-Grid. **ONLY "Limited Power to Load"** (default).
5. The **"Auto Gen-Start"** function is a dry-contact, normally open 2-wire switch (closes the circuit when needing charging).
  - o Auto Gen-start will be triggered when the battery voltage (V) or percent (%) reaches the level programmed in the Battery Setup menu. Then, the generator will continue to charge the batteries until they are about 95% full. **!** Without Time of Use, this 95% value is not programmable.
  - o An exercise function will turn on the generator once a week on Monday mornings at 8 AM for 20 min by default. This exercise is to maintain the internal generator batteries.
6. When using a Generator in an Off-Grid situation, we recommend changing the **"Grid Mode"** to **"General Standard"** and changing the **"Grid Reconnect Time"** under the **"Sell Control"** tab of the Grid Setup menu to 30 seconds.
7. In the **"Connect"** tab under **"Reconnect"** and **"Normal connect"**, change the frequency to a range of 55Hz - 65Hz. Widening the range will reduce the number of disconnections from fluctuations in a generator's frequency.
8. Under the **"Grid Setup"** menu → **Limiters** → **Other**, make sure to check the **" GEN connected to Grid Input"** box.
9. If planning on using a wind turbine in conjunction with the Sol-Ark, the turbine must have a 48V charge controller with a dump load to prevent battery overcharging. This charge controller must be connected directly to the battery bank of the Sol-Ark.

### Grid-Tie and No Battery Install Tips (Passthrough mode)

1. Under **"Battery setup"**, select **"No Battery"** & disable **"Activate Battery"** (the system will fault and start beeping).
2. **!** A complete **Power Cycle IS REQUIRED** when changing the battery mode to **"No Battery"** (see section 2.11 "Power cycle Sequence" for detailed instructions).
3. Under **"Grid Setup"**, select **"Grid Sell"** and disable all other modes.
4. Touch the Battery Icon to see the Detailed Volts View to verify your inputs & outputs

## 4.1 Battery Charge Controller

### 4-Stage Charging

The MPPT has a 4-stage battery charging algorithm for rapid, efficient, and safe battery charging. The next figure shows the stage sequence.

### Bulk Charge Stage

In the Bulk Charge stage, the battery is not at a 100% state of charge and has not yet reached the Absorption voltage setpoint. The controller will deliver 100% of available solar power to recharge the battery.

### Absorption Stage

When the battery has reached the absorption voltage setpoint, the Sol-Ark inverter uses constant-voltage regulation to maintain battery voltage at the absorption setpoint, preventing overheating and excessive battery gassing. The battery is allowed to come to a full state of charge at the absorption voltage setpoint. Absorption lasts until the battery charge amperage (A) rate reaches 2% of the programmed capacity (Ah).

### Float Stage

After the Absorption stage charges the battery fully, the MPPT reduces the battery voltage to the float voltage setpoint. If the batteries have 100% charge, there can be no more chemical reactions and all the charging current turns into heat and gassing. The Float stage provides a meager rate of maintenance charging while reducing the heating and gassing of a fully charged battery. The purpose of the Float stage is to protect the battery from long-term overcharge.

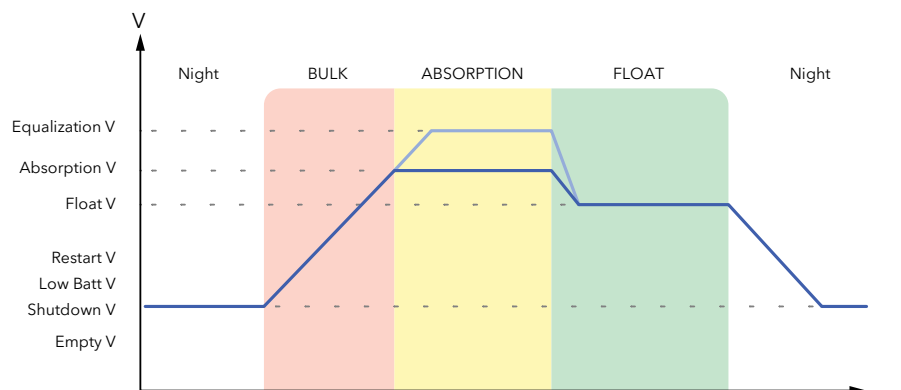

Figure 33: Charge controller curve

## Battery Charging Setpoint Examples (48V Nominal)

| Battery Type | Absorption | Float | Equalize<br>(Every 30 days for<br>3hr) |
|--------------|------------|-------|--|
| AGM / PCC    | 57.6V      | 53.6V | 57.6V                                  |
| Gel          | 56.4V      | 54.0V |  |
| Wet          | 59.0V      | 55.0V | 59.0V                                  |
| Lithium      | 54.6V      | 54.3V | -                                      |

**⚠** Follow all battery manufacturer-specified values to ensure proper charging and discharging

## Calculating Battery Bank Amp-Hours Examples (AGM)

| # of batteries | Voltage per Battery | Ah per battery | Ah @48V<br>(Chain of 4<br>batteries of 12V in<br>series) | Max Charge<br>Discharge (A) |
|----------------|---------------------|----------------|--|-----------------------------|
| 4              | 12V                 | 230Ah          | 230Ah  | 100A                        |
| 8              | 12V                 | 230Ah          | 460Ah  | 200A                        |
| 12             | 12V                 | 230Ah          | 690Ah  | 275A                        |

## 4.2 Battery Communication with MODBUS/CANBUS

**⚠** Any damage caused by the improper use of the communication protocols (CANBUS or MODBUS) will not be covered by warranty. Modbus map is available upon request for "READ" operations only. Contact technical support at [support@sol-ark.com](mailto:support@sol-ark.com) to obtain the MODBUS map.

### RJ-45 Configurations

The Sol-Ark 15K-2P-N inverter achieves battery communications through a single RJ-45 port labeled "Battery CANBus". This port combines the RS-485 and CAN pin configurations shown below. Both "Modbus RS485" and "Battery CANBus" ports are capable of Modbus communication.

| Pin | RS485     | CAN    |
|-----|-----------|--------|
| 1   | RS-485 A+ | --     |
| 2   | RS-485 B- | --     |
| 3   | --        | --     |
| 4   | --        | CAN Hi |
| 5   | --        | CAN Lo |
| 6   | GND       | GND    |
| 7   | RS485 A+  | --     |
| 8   | RS485 B-  | --     |

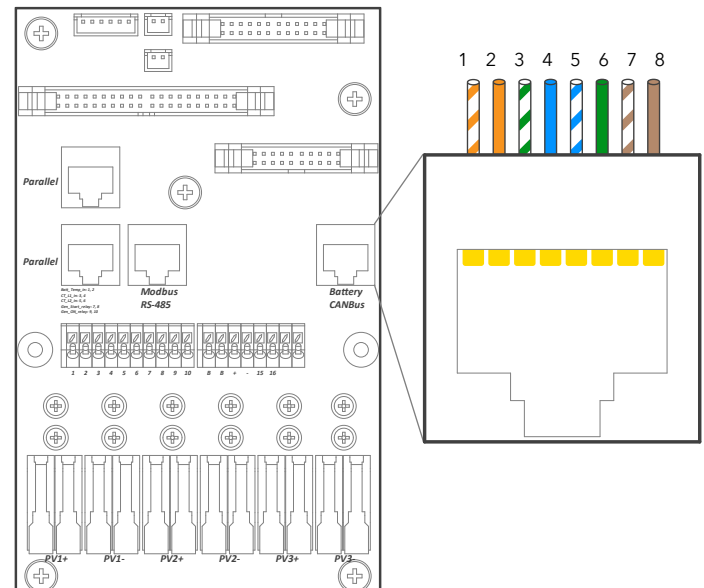

Figure 34: RJ-45 port configuration

**!** Complete battery integration guide of supported battery communications can be found at: [www.sol-ark.com/battery-partners](http://www.sol-ark.com/battery-partners)

### External MODBUS Devices

If an external device utilizes **BMS Lithium Batt 00**, one must change the **Modbus SN** of the inverter to **01** as the default value is 00.

# 4.3 Grid Compliance Settings

## Puerto Rico Grid Compliance Settings

| Grid Param                            |         |    |       |           |           |
|---------------------------------------|---------|----|-------|-----------|-----------|
| Grid selection                        | Connect | IP | F(W)  | V(W)/V(Q) | P(Q)/P(F) |
| Over Voltage U>(10 min. running mean) |         |    |       |           | 239.2V    |
| HV3                                   | 288.0V  |    |       | HF3       | 61.50Hz   |
| HV2                                   | 288.0V  | -- | 0.16s | HF2       | 61.50Hz   |
| HV1                                   | 264.0V  | -- | 1.00s | HF1       | 60.50Hz   |
| LV1                                   | 211.2V  | -- | 2.00s | LF1       | 59.20Hz   |
| LV2                                   | 144.0V  | -- | 1.00s | LF2       | 57.50Hz   |
| LV3                                   | 108.0V  |    |       | LF3       | 57.50Hz   |
| CANCEL                                |         |    | OK    |           |           |

## HECO Grid Compliance Settings

120/240V

| Grid Param          |         |    |                |                  |           |
|---------------------|---------|----|----------------|------------------|-----------|
| Grid Selection      | Connect | IP | F(W)           | V(W)/V(Q)        | P(Q)/P(F) |
| Reconnect           |         |    | Normal connect |                  |           |
| Grid Vol High       | 252.0V  |    |                | Grid Vol High    | 252.0V    |
| Grid Vol Low        | 211.2V  |    |                | Grid Vol Low     | 211.2V    |
| Grid Hz High        | 60.1Hz  |    |                | Grid Hz High     | 60.1Hz    |
| Grid Hz Low         | 59.5Hz  |    |                | Grid Hz Low      | 59.5Hz    |
| Reconnect Ramp rate | 300s    |    |                | Normal Ramp rate | 300s      |
| CANCEL              |         |    | OK             |                  |           |

| Grid Param                            |         |    |        |           |           |
|---------------------------------------|---------|----|--------|-----------|-----------|
| Grid selection                        | Connect | IP | F(W)   | V(W)/V(Q) | P(Q)/P(F) |
| Over Voltage U>(10 min. running mean) |         |    |        |           | 276.0V    |
| HV3                                   | 288.0V  |    |        | HF3       | 65.00Hz   |
| HV2                                   | 288.0V  | -- | 0.16s  | HF2       | 65.00Hz   |
| HV1                                   | 264.0V  | -- | 13.00s | HF1       | 63.00Hz   |
| LV1                                   | 211.2V  | -- | 21.00s | LF1       | 57.00Hz   |
| LV2                                   | 168.0V  | -- | 2.00s  | LF2       | 50.00Hz   |
| LV3                                   | 120.0V  |    |        | LF3       | 49.90Hz   |
| CANCEL                                |         |    | OK     |           |           |

120/208V

| Grid Param          |         |    |                |                  |           |
|---------------------|---------|----|----------------|------------------|-----------|
| Grid Selection      | Connect | IP | F(W)           | V(W)/V(Q)        | P(Q)/P(F) |
| Reconnect           |         |    | Normal connect |                  |           |
| Grid Vol High       | 218.4V  |    |                | Grid Vol High    | 218.4V    |
| Grid Vol Low        | 183.1V  |    |                | Grid Vol Low     | 183.1V    |
| Grid Hz High        | 60.1Hz  |    |                | Grid Hz High     | 60.1Hz    |
| Grid Hz Low         | 59.5Hz  |    |                | Grid Hz Low      | 59.5Hz    |
| Reconnect Ramp rate | 300s    |    |                | Normal Ramp rate | 300s      |
| CANCEL              |         |    | OK             |                  |           |

| Grid Param                            |         |    |        |           |           |
|---------------------------------------|---------|----|--------|-----------|-----------|
| Grid selection                        | Connect | IP | F(W)   | V(W)/V(Q) | P(Q)/P(F) |
| Over Voltage U>(10 min. running mean) |         |    |        |           | 239.2V    |
| HV3                                   | 249.6V  |    |        | HF3       | 65.00Hz   |
| HV2                                   | 249.6V  | -- | 0.16s  | HF2       | 65.00Hz   |
| HV1                                   | 228.8V  | -- | 13.00s | HF1       | 63.00Hz   |
| LV1                                   | 183.0V  | -- | 21.00s | LF1       | 57.00Hz   |
| LV2                                   | 145.6V  | -- | 2.00s  | LF2       | 50.00Hz   |
| LV3                                   | 104.0V  |    |        | LF3       | 49.90Hz   |
| CANCEL                                |         |    | OK     |           |           |

Frequency-Watt, Volt-Watt and Volt-Var

| Grid Param      |         |               |         |  |           |
|-----------------|---------|---------------|---------|--|-----------|
| Grid selection  | Connect | IP            | F(W)    | V(W)/V(Q)                                | P(Q)/P(F) |
| Over frequency  |         | Droop F       |         | 50%PE/Hz                                 |           |
| Start freq F    | 60.04Hz | Stop freq F   | 60.50Hz | <input checked="" type="checkbox"/> F(W) |           |
| Start delay     | 0.00s   | Stop delay    | 0.00s   |  |           |
| Under frequency |         | Droop F>      |         | 50%PE/Hz                                 |           |
| Start freq F>   | 59.96Hz | Stop freq F>  | 59.50Hz |  |           |
| Start delay F>  | 0.00s   | Stop delay F> | 0.00s   |  |           |
| CANCEL          |         |               | OK      |  |           |

| Grid Param     |         |            |  |  |           |
|----------------|---------|------------|--|--|-----------|
| Grid selection | Connect | IP         | F(W)                                     | V(W)/V(Q)                                | P(Q)/P(F) |
|                |         |            | <input checked="" type="checkbox"/> V(W) | <input checked="" type="checkbox"/> V(Q) |           |
| Response_T     | 5S      | L.in:20.0% |  | L.out:5.0%                               |           |
| V1:106.0%      | P1:100% | V1:92.0%   | Q1:44%                                   |  |           |
| V2:110.9%      | P2: 0%  | V2:98.0%   | Q2: 0%                                   |  |           |
| V3:110.0%      | P3: 0%  | V3:100.0%  | Q3: 0%                                   |  |           |
| V4:110.0%      | P4: 0%  | V4:106.0%  | Q4:44%                                   |  |           |
| CANCEL         |         |            | OK                                       |  |           |

# 5. Parallel Systems

## 5.1 Before Enabling Parallel Operations

- Make sure all units in parallel have the same software version by verifying the **"COMM"** and **"MCU"** numbers on System Setup.
- Go to <https://www.sol-ark.com/software-update/> to schedule an update or call/email Tech Support for assistance: support@sol-ark.com
- ⚠️** Parallel systems **REQUIRE** a joint battery bank. If you do not have a battery, keep all Sol-Ark inverters **OUT** of parallel and set every System to **"Grid Sell"** Mode.
- All INPUTS/OUTPUTS must be shared among **ALL** parallel inverters, with the exception for DC solar inputs.

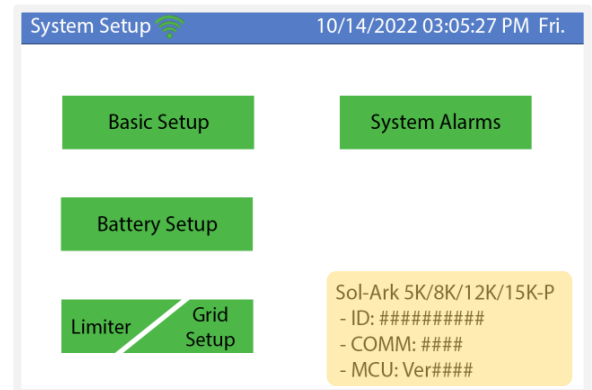

Figure 35: Software version check

## DIP Switch Configuration for Parallel Systems

In parallel systems, set the "DIP Switches" shown in the following, according to the table below.

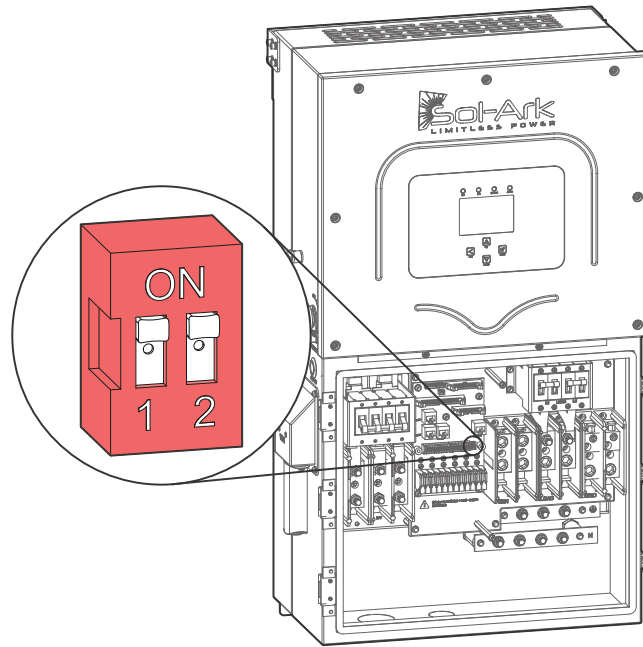

Figure 36: Sol-Ark DIP switches

| Inverter 1 (Master) | Inverter 2  | Inverter 3 | Inverter 4 | Inverter 5 | Inverter 6 | Inverter 7 | Inverter 8 |
|---------------------|-------------|------------|------------|------------|------------|------------|------------|
| OFF                 |             |            |            |            |            |            |            |
| <b>! ON</b>         | <b>! ON</b> |            |            |            |            |            |            |
| OFF                 | ON          | OFF        |            |            |            |            |            |
| OFF                 | ON          | ON         | OFF        |            |            |            |            |
| OFF                 | ON          | ON         | ON         | OFF        |            |            |            |
| OFF                 | ON          | ON         | ON         | ON         | OFF        |            |            |
| OFF                 | ON          | ON         | ON         | ON         | ON         | OFF        |            |
| OFF                 | ON          | ON         | ON         | ON         | ON         | ON         | OFF        |

**!** Parallel systems with 2 inverters must have their DIP switches on the ON position

## Parallel Systems Sol-Ark 15K-2P-N @ 120/240V Split-Phase

| # of inverters in parallel | Continuous output power with PV (kW) | Continuous output power with batteries (kW) | Grid "Pass Through" (A) | Peak power 10 sec (kVA) |
|----------------------------|--------------------------------------|---|-------------------------|-------------------------|
| 1                          | 15                                   | 12  | 200                     | 24                      |
| 2                          | 30                                   | 24  | 400                     | 48                      |
| 3                          | 45                                   | 36  | 600                     | 72                      |
| 4                          | 60                                   | 48  | 800                     | 96                      |
| 5                          | 75                                   | 60  | 1000                    | 120                     |
| 6                          | 90                                   | 72  | 1200                    | 144                     |
| 7                          | 105                                  | 84  | 1400                    | 168                     |
| 8                          | 120                                  | 96  | 1600                    | 192                     |
| 9                          | 135                                  | 108   | 1800                    | 216                     |
| 10                         | 150                                  | 120   | 2000                    | 240                     |
| 11                         | 165                                  | 132   | 2200                    | 264                     |
| 12                         | 180                                  | 144   | 2400                    | 288                     |

## Parallel Systems Sol-Ark 15K-2P-N @ 120/208V 3-Phase

| # of inverters in parallel    | Continuous output power with PV (kW) | Continuous output power with batteries (kW) | Grid "Pass Through" (A) | Peak power 5 sec (kVA) |
|-------------------------------|--------------------------------------|---|-------------------------|------------------------|
| 1 (only 2 phases)             | 13                                   | 12  | 200                     | 24                     |
| 2 (all phases but unbalanced) | 26                                   | 24  | 400                     | 48                     |
| 3                             | 39                                   | 36  | 400                     | 72                     |
| 6                             | 78                                   | 72  | 800                     | 144                    |
| 9                             | 117                                  | 108   | 1200                    | 216                    |
| 12                            | 156                                  | 144   | 1600                    | 288                    |

## 5.2 Parallel Systems Programming Sequence

1. Program each one of the units for parallel under "Basic Setup" →  Parallel".
2. Assign a System as "**Master**" | **Modbus SN: 1**
3. Assign all other units as "**Slave**" | **Modbus SN: 2,3,4...etc.**
  - o If system is 3-phase, there must be a master for each phase (Master Phase A, Master Phase B, Master Phase C)
4. Connect communication cables between the inverters using the RJ45 cable (yellow ethernet cable) in daisy-chain configuration between ports: "Parallel 1" or "Parallel 2" from Master into Slave.
5. Perform a power cycle (see section 2.11 "Power Cycle Sequence" for power cycle sequence instructions).
6. Once shut down completely, turn on the "Slave" units **FIRST** working backwards. Then turn ON the "Master" **LAST**.
7. Inverters will likely fault momentarily with F29 and F41 codes until all inverters are ON.
8. REMEMBER: All inverters must be connected to the **SAME BATTERY BANK**.



When integrating a generator, it must be connected to all the systems in parallel. The inverter assigned as "Master" will control the two-wire start feature

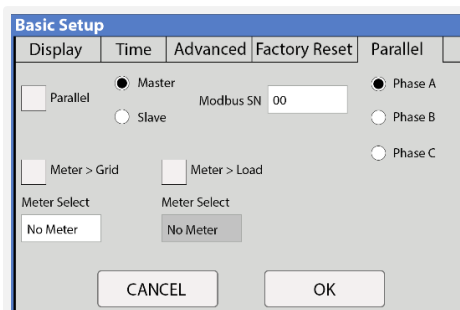
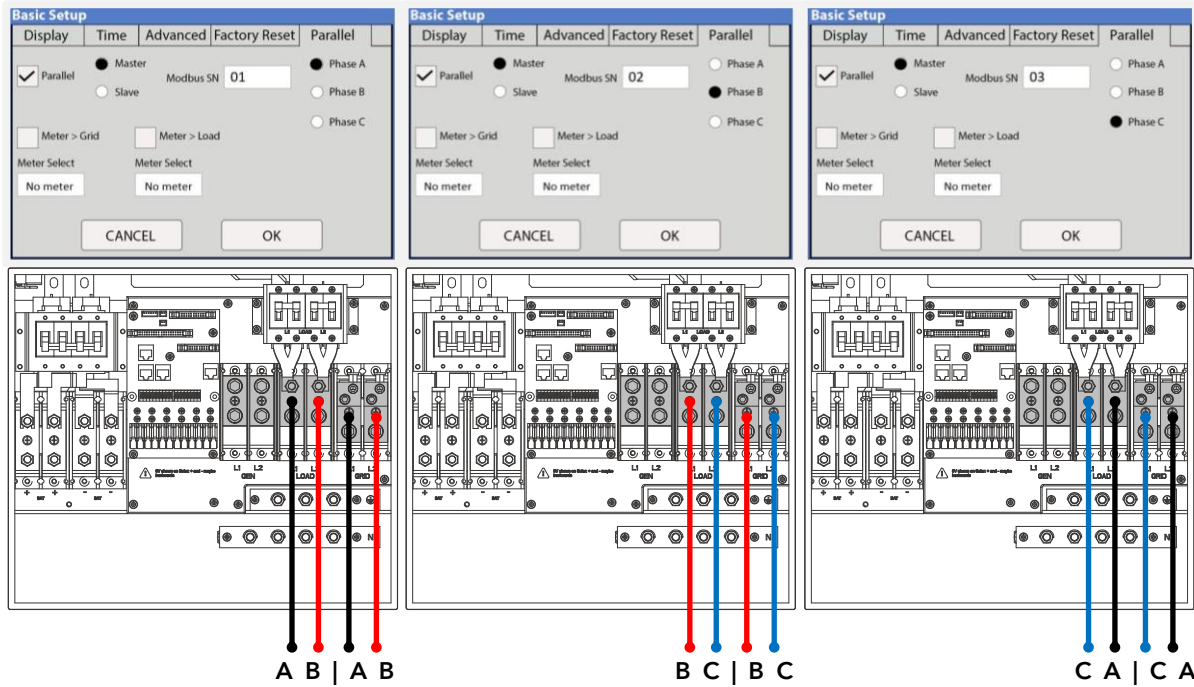

Figure 37: Parallel setup tab

# Parallel Configuration (Example on a 3 Phase System-Balanced). Phase A-B-C

A 3-Phase balanced system requires at least 3 Sol-Ark Units. Programming and wiring should follow the below images.



## Examples of 3-Phase Parallel Configurations

1 inverter @ 120/208V  
Using 2 phases of 3

2 inverters @ 120/208V  
Using 2 phases of 3

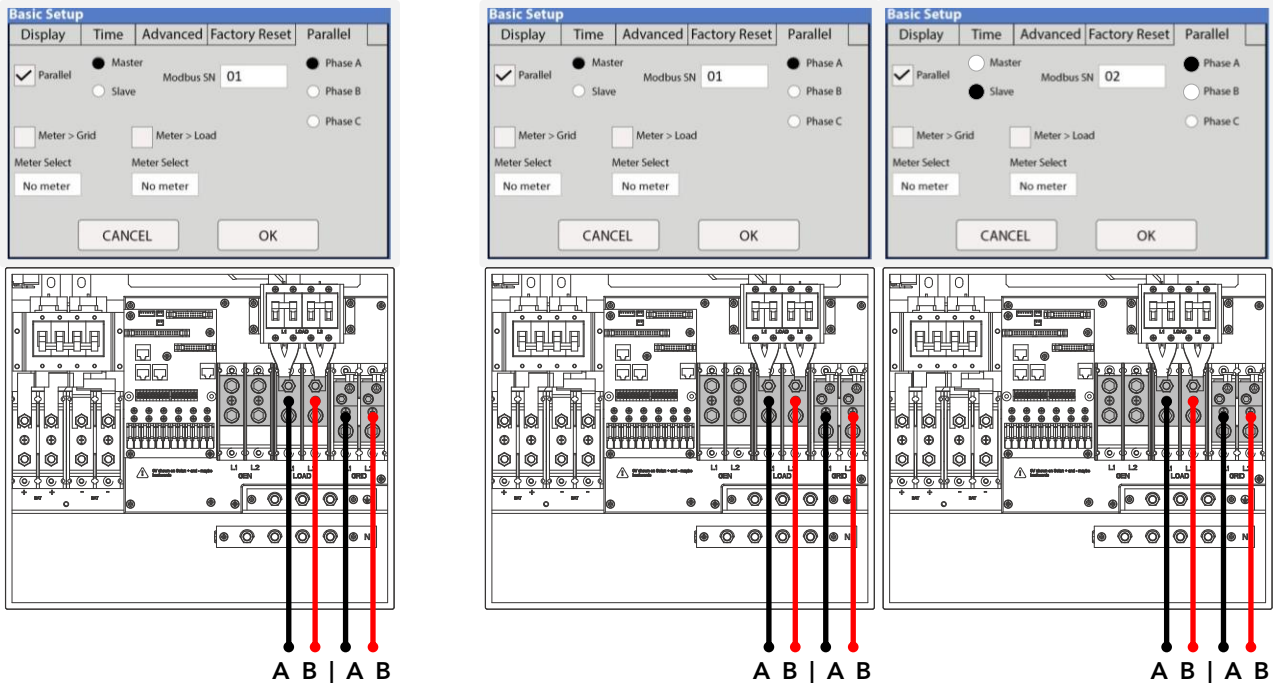

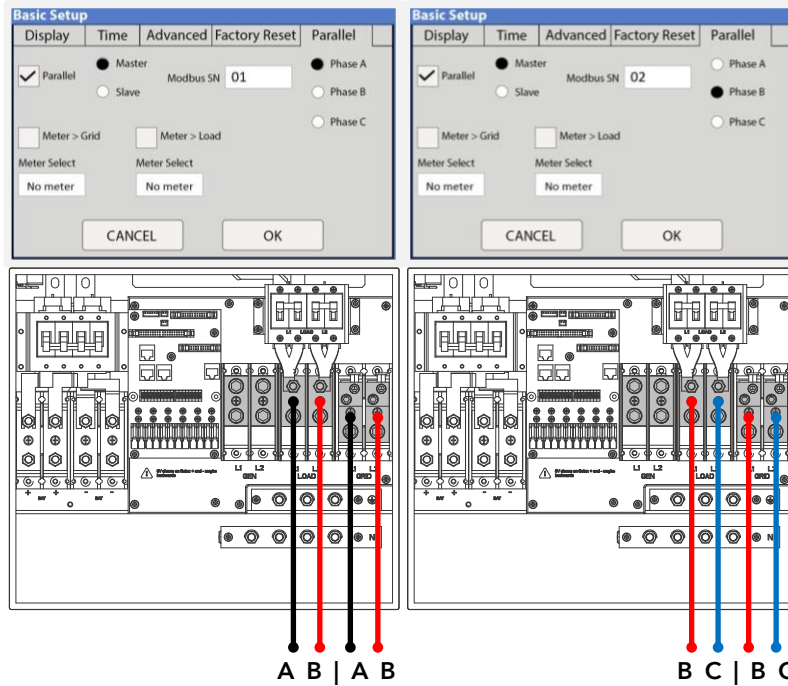

## 5.3 Three-Phase Systems: Programming and Troubleshooting

3-phase systems with multiple Sol-Ark inverters must be programmed according to the table below:

| # of inverters | Programming  |
|----------------|--|
| 2              | Master Phase A 01   Master Phase B 02  |
| 3              | Master Phase A 01   Master Phase B 02   Master Phase C 03  |
| 6              | Master $\Phi$ A 01, Slave $\Phi$ A 02   Master $\Phi$ B 03, Slave B 04   Master $\Phi$ C 05, Slave $\Phi$ C 06   |
| 9              | Master $\Phi$ A 01, Slave $\Phi$ A 02, Slave $\Phi$ A 03   Master $\Phi$ B 04, Slave $\Phi$ B 05, Slave $\Phi$ B 06   Master $\Phi$ C 07, Slave $\Phi$ C 08, Slave $\Phi$ C 09 |

### Troubleshooting Guide with Phase Sequence

**⚠** If the screen of your Sol-Ark inverter shows the error shown below, ensure the phase sequence follows **AB-BC-CA** convention. The message "Grid Phase Wrong" is displayed when the inverter does not detect the correct phase rotation. This situation can cause overloads faults in the system (F18, F26, F34) even with the "LOAD" disconnected and **WILL CAUSE DAMAGE** to the equipment if it is not corrected.

|              | L1 | L2 |
|--------------|----|----|
| Inverter (1) | A  | B  |
| Inverter (2) | B  | C  |
| Inverter (3) | C  | A  |

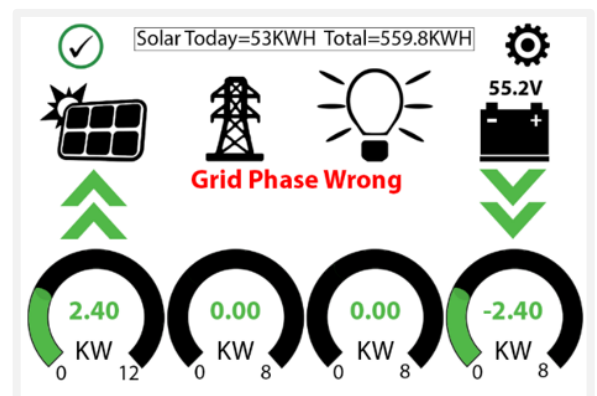

Figure 38: Grid phase wrong error



How to find an incorrect phase if prompted "Grid Phase Wrong"?

- Measure L1 GRID of inverter (1) to L2 GRID of inverter (3). Should be 0Vac.
- Measure L2 GRID of inverter (1) to L1 GRID of inverter (2). Should be 0Vac.
- Measure L2 GRID of inverter (2) to L1 GRID of inverter (3). Should be 0Vac.
- Same process should be done for LOAD side.
- Measuring voltage different than 0Vac means the measured lines are not the same phase.
- **Sol-Ark can only receive direct rotation "C" (clockwise).**

Be sure to check both, GRID and LOAD terminal connections; both must be correct. If the error persists you will need to check your AC connection beyond the inverter and you will need to verify that the phases are correctly labeled from your meter.

*\*In 3 phase systems it is recommended to use a rotational tester (1-2-3, A-B-C).*

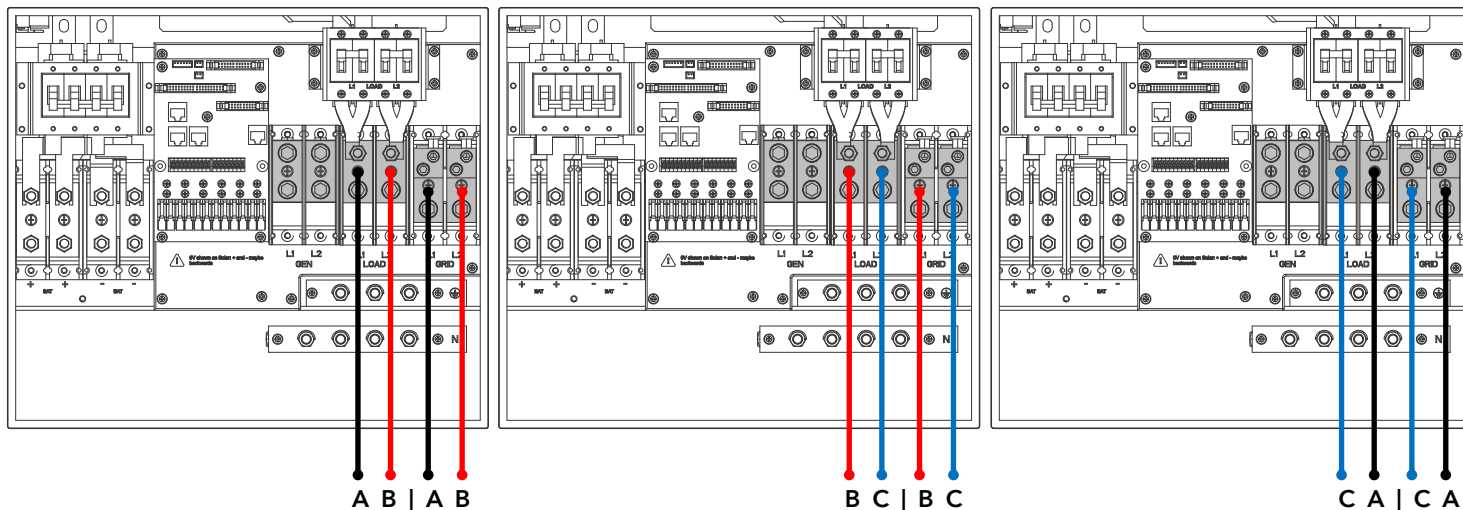

Figure 39: Example of correct phase sequence



If an inverter goes into a fault state, all other units will stop and follow. The system will automatically self-reboot. If the system faults 5 consecutive times, it will stop completely and it will require a manual restart. See section 2.11 "Power cycle sequence" for detailed instructions.

## 6. Wi-Fi / Ethernet Connection

### 6.1 Ethernet Connection

- Remove the plastic enclosure of the dongle by pressing the plastic latches with a flat screwdriver as shown in the following figure.
- Insert the ethernet cable through the plastic enclosure and connect the cable to the RJ45 port.
- Reassemble the dongle housing and plug the dongle into the Sol-Ark. Secure with screws (see figure 41). You will see solid red and green lights after a couple of minutes.
- Follow "STEP 1" instructions on the following page in order to create a plant on our monitoring platform.

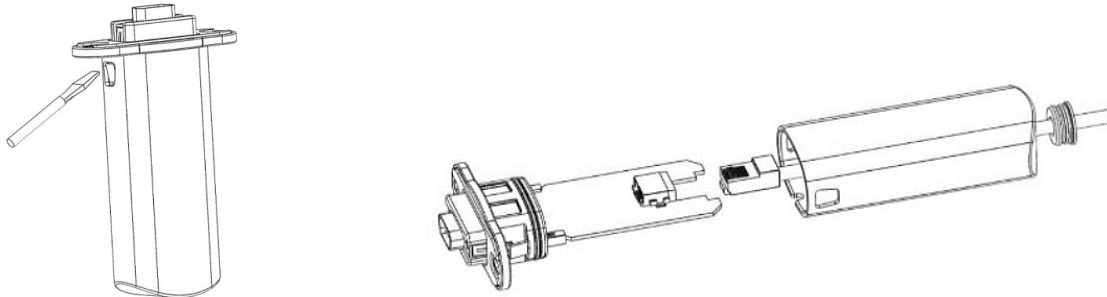

Figure 40: Connecting Wi-Fi dongle to ethernet

### 6.2 Wi-Fi (PC or Smart Phone)

- Plug the Wi-Fi dongle into Sol-Ark DB-9 port.
- Use two M4X10 screws to secure the dongle as shown below.
- A solid red LED will light up, indicating the dongle is being powered.
- Follow the next set of instructions in order to:
  - Create a plant on the Sol-Ark monitoring platform
  - Connect the Wi-Fi dongle to the internet for remote monitoring

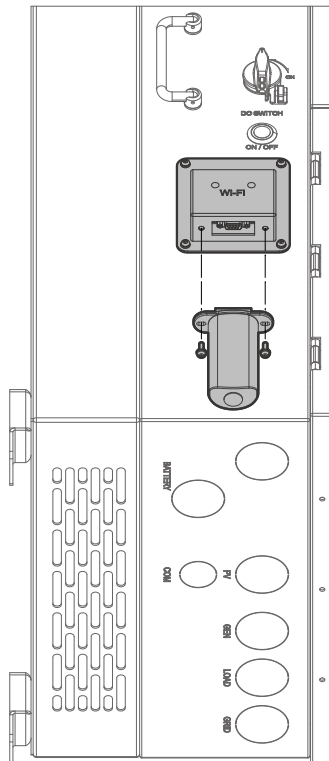

Figure 41: Connecting Wi-Fi dongle to Sol-Ark 15K-2P-N

## STEP 1: Create a "Plant"

### A. Download the app for smart phones - "PV Pro"



a) iPhone IOS



b) Android



#### Installers

It is recommended that the installer creates the plant and share it later with MANAGER permission to the owner of the system. Once created, the installer or the homeowner can share the plant and assign Manager permissions on "My Plants" → "... " → "Share" → "Add Account".

*TIP: If you want to share a plant, a PowerView account with the new email must be created.*

### B. Create PowerView / PV Pro account and login.

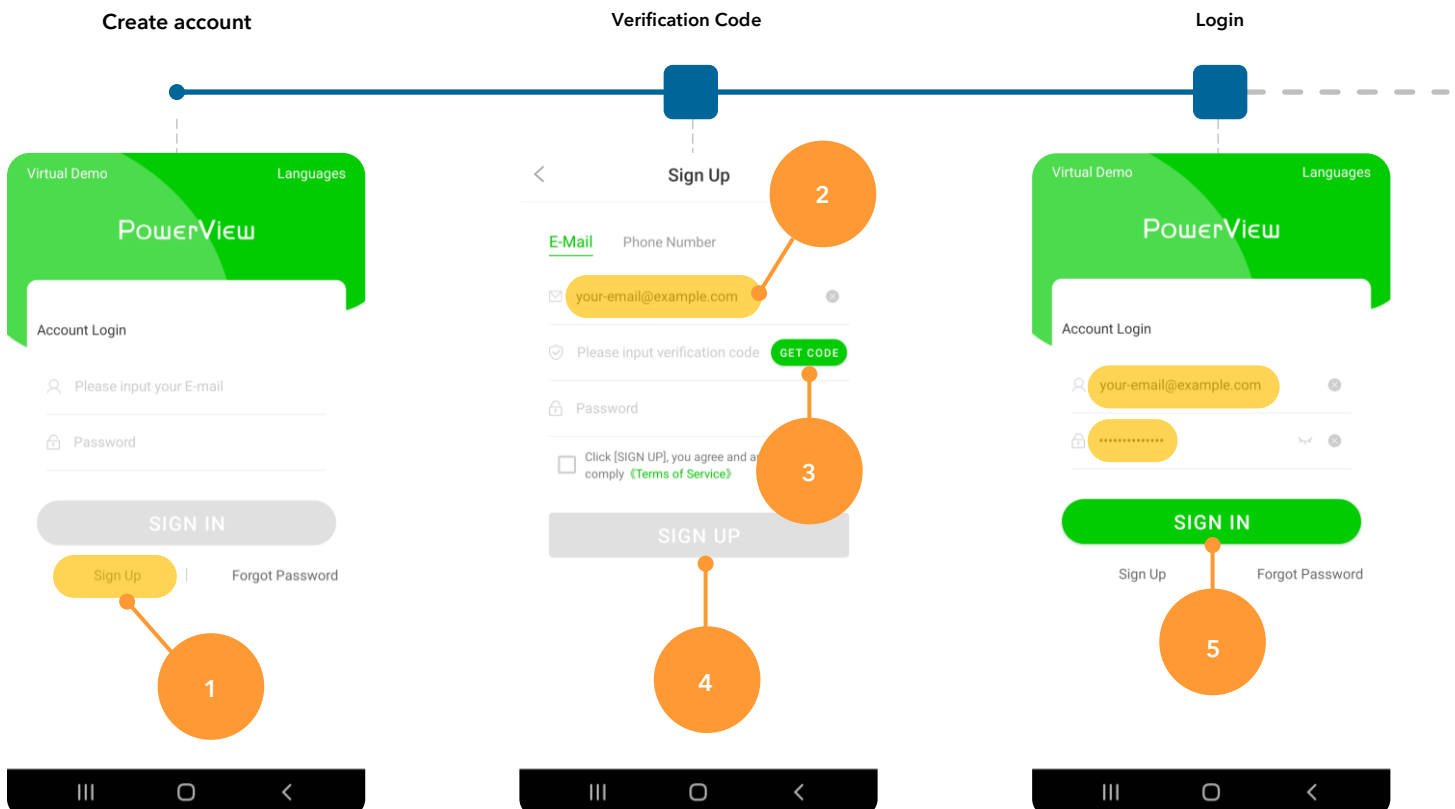

### C. Create Plant.

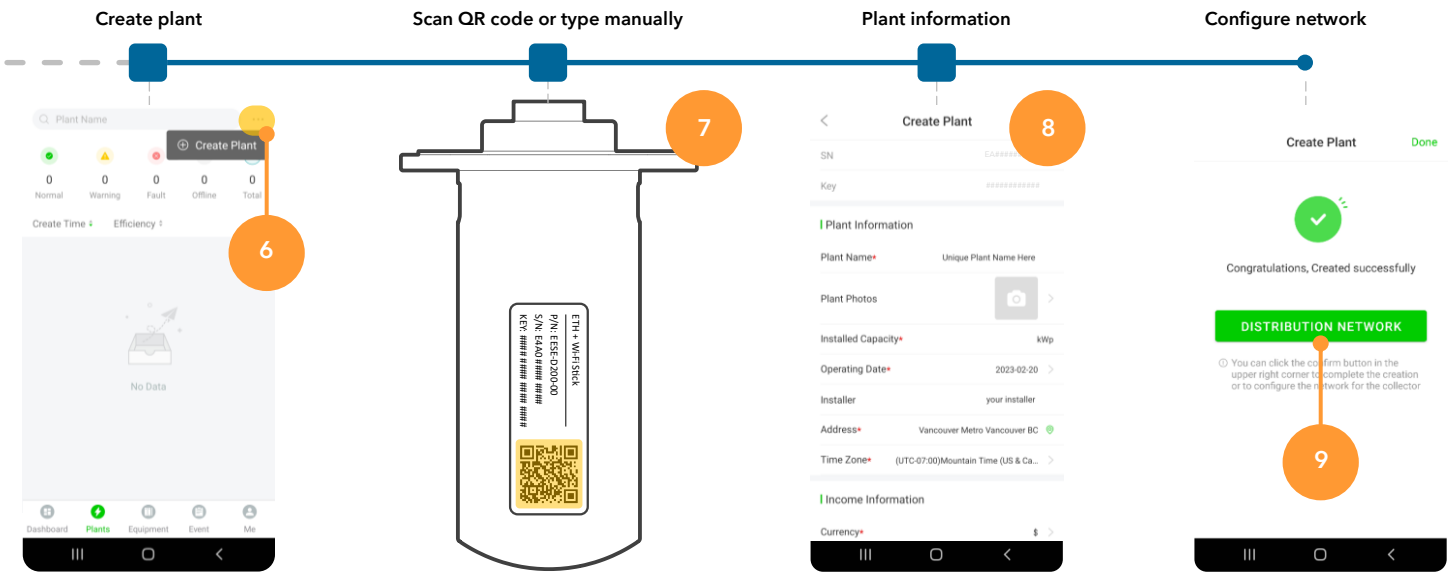

## STEP 2: Configure Wi-Fi network though PV Pro

### D. Configure Wi-Fi network.

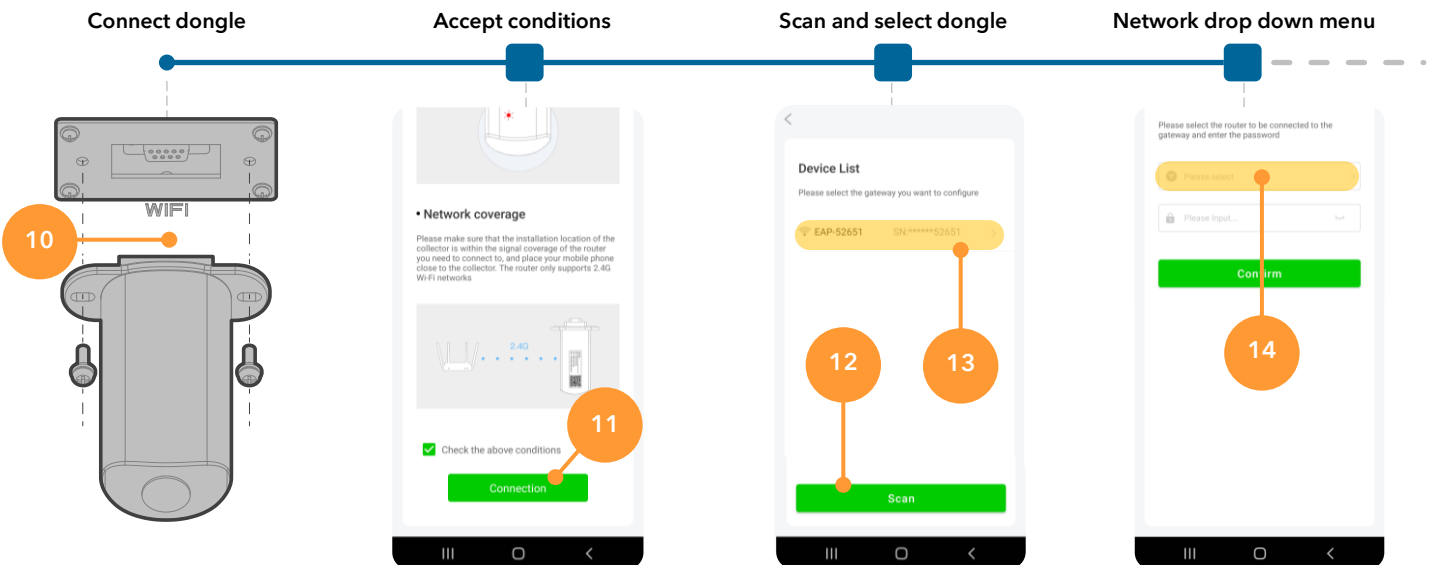

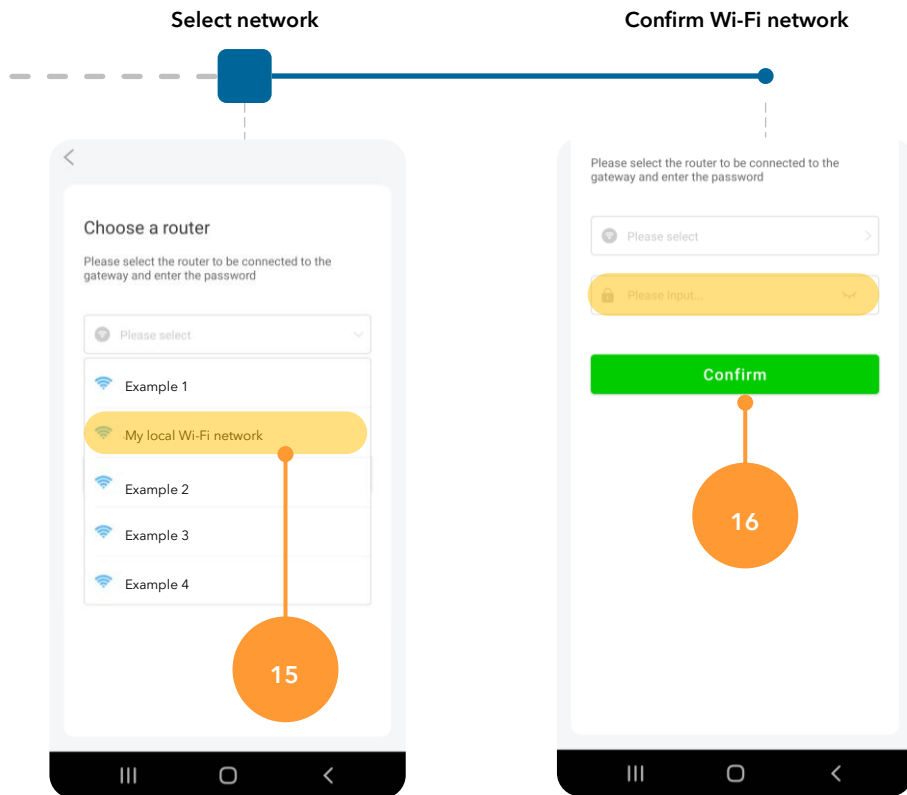

### STEP 3 (Optional): Configure Wi-Fi Network Through IP Address

- If setting up a Wi-Fi connection through the "Distribution Network" at the end of step C was skipped, you can still configure a Wi-Fi network through an IP address.
- On your Smart Phone or Computer go to: **Settings** → **Wi-Fi** → Select the **EAP-#####** network → **Password= 12345678**
  - The EAP-##### network contains the last 5 digits of the Dongle Serial Number. You can find this number on the label.
- Once your device is connected to the Dongle you will get the following message ("Connected without internet").

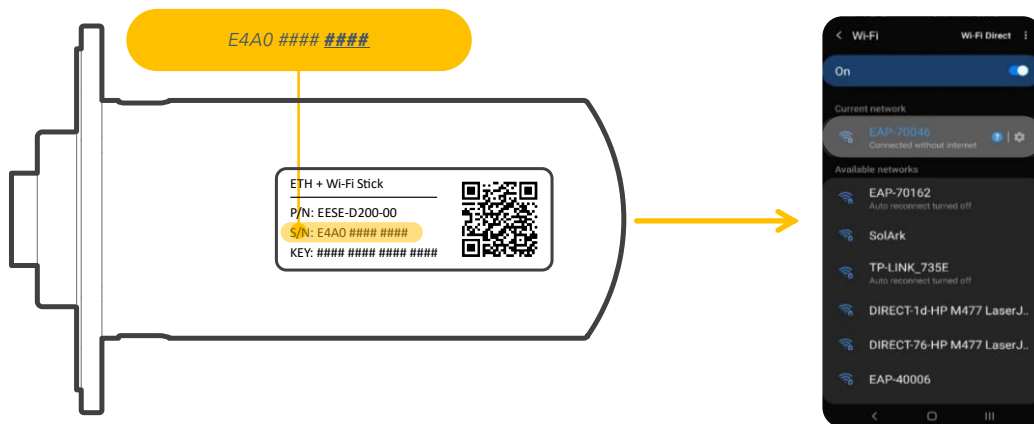
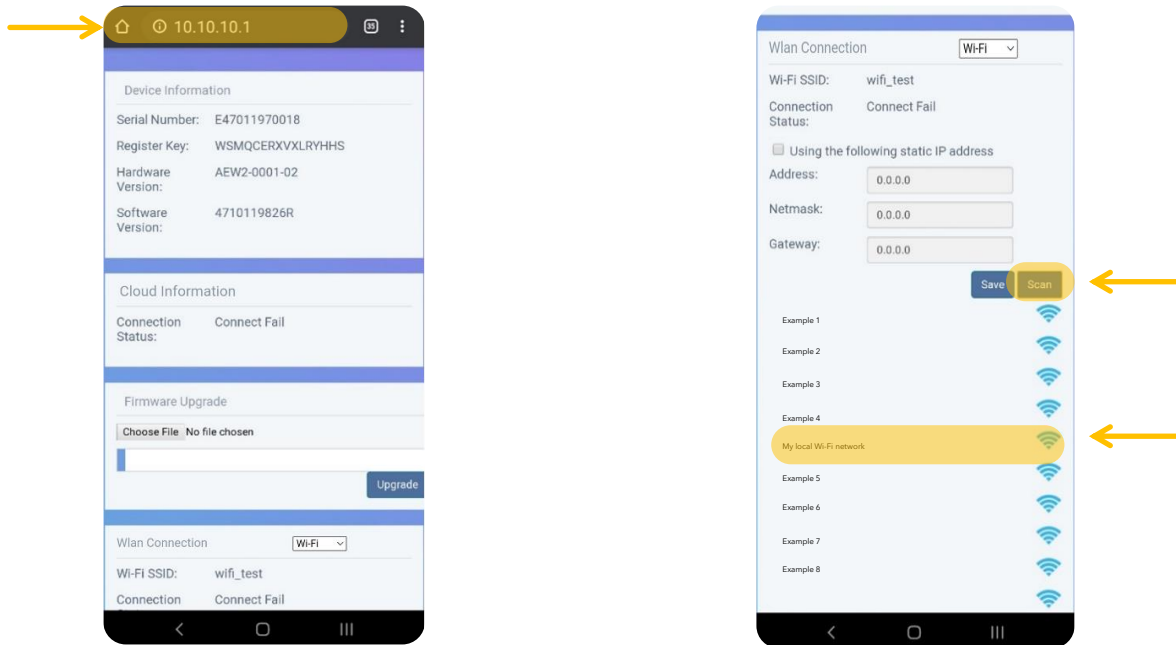

Figure 42: E4A0-##### serial number and EAP network

**NOTE:** The Wi-Fi dongle does NOT provide internet access. It needs an external internet provider to connect to.  
The dongle is compatible with Wi-Fi signal broadcasted at 2.4 GHz (*it is not possible to use 5 GHz*)

- D. Once your device is connected to the dongle, open an internet browser (Safari, Google, Chrome, etc.)
- E. On the address bar (http://.....), type the following IP address: **10.10.10.1** as shown in the figure below. If you can't access the configuration page, try again with a different device or computer.
- F. Scroll down to the "Wlan Connection" section.
- G. Press the "Scan" button to search local networks.
- H. Select Home network and input personal credentials.
- I. Select "Connect".
- J. **Do NOT select the EAP-#### network as that is the dongle itself.**



a) Internet browser IP address

b) Wi-Fi network scan

Figure 43: IP address setup page

- K. Press "Save" to save your information.
- L. Wait a moment (5 min) for the dongle to connect to the router and the server.

If successful, you should see a red and green light on the dongle showing a solid connection.

- o **RED LED:** Connected to Sol-Ark and has power.
- o **GREEN LED:** Connected to router and server.
- o **FLASHING GREEN LED:** Connected to router but not server (usually a VPN or Firewall issue, ports 80 and 51100 must be enabled).

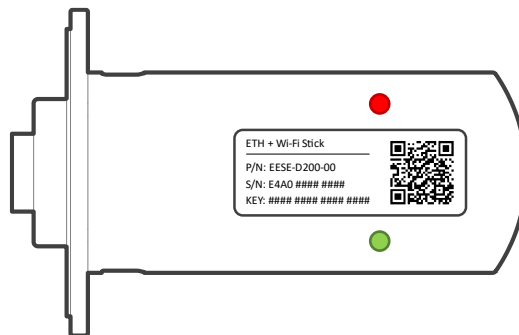

Figure 44: Wi-Fi dongle LED indicators

**!** Connecting the Wi-Fi dongle using the IP address 10.10.10.1 to your home Wi-Fi network is only meant to provide internet access to the inverter. **You must still create a PowerView account**

You can access PowerView on a computer with the following link:

[www.mysol-ark.com](http://www.mysol-ark.com)

# 7. Wiring Diagrams

⚠️ These wiring diagrams are examples of common use-cases for Sol-Ark inverters. Diagrams must meet local electrical code and authorized jurisdiction requirements. Sol-Ark does not provide custom diagrams; however, you may contact [support@sol-ark.com](mailto:support@sol-ark.com) for questions about existing diagrams

Sol-Ark 15K-2P-N  
Standard Wiring Diagram

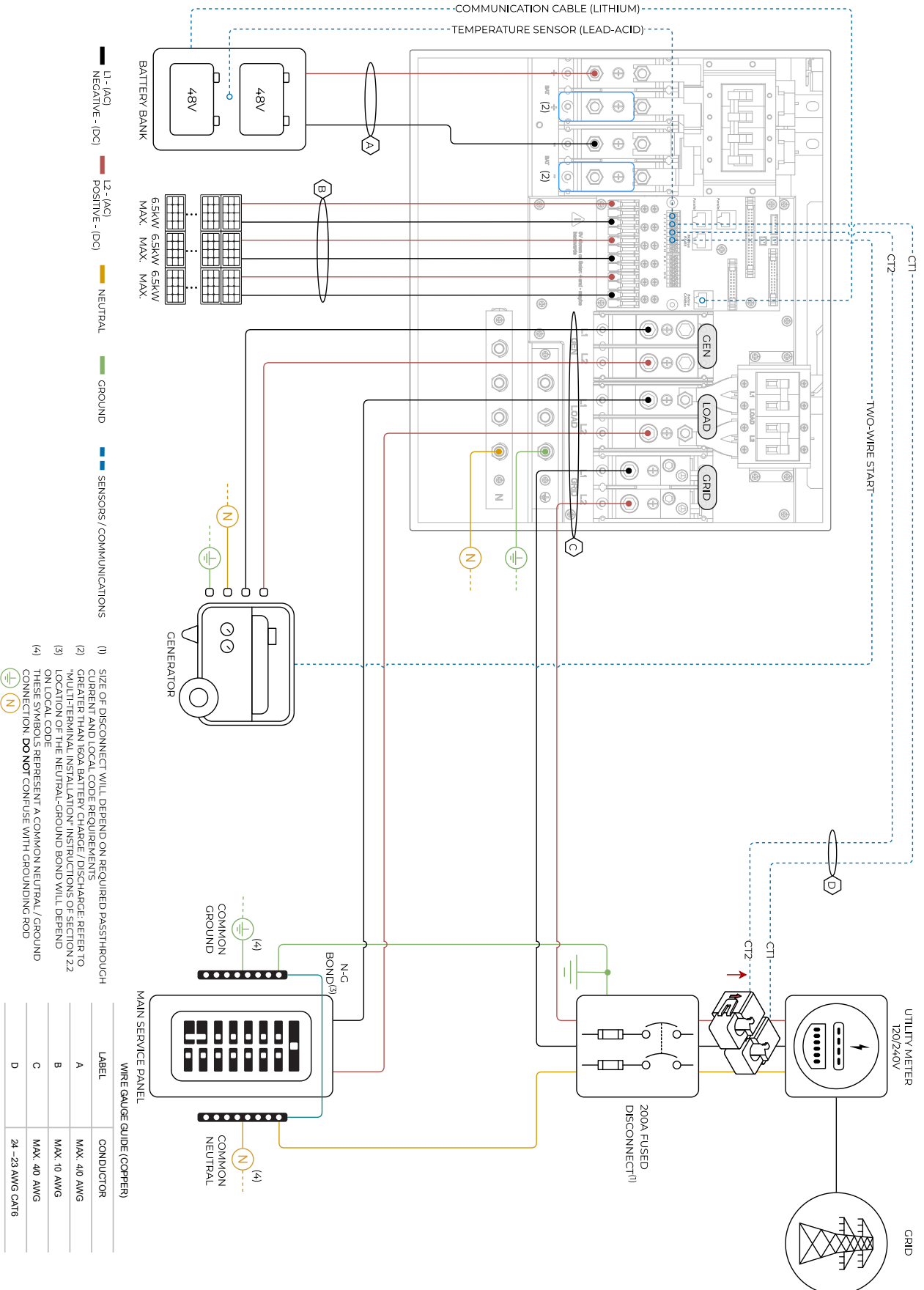
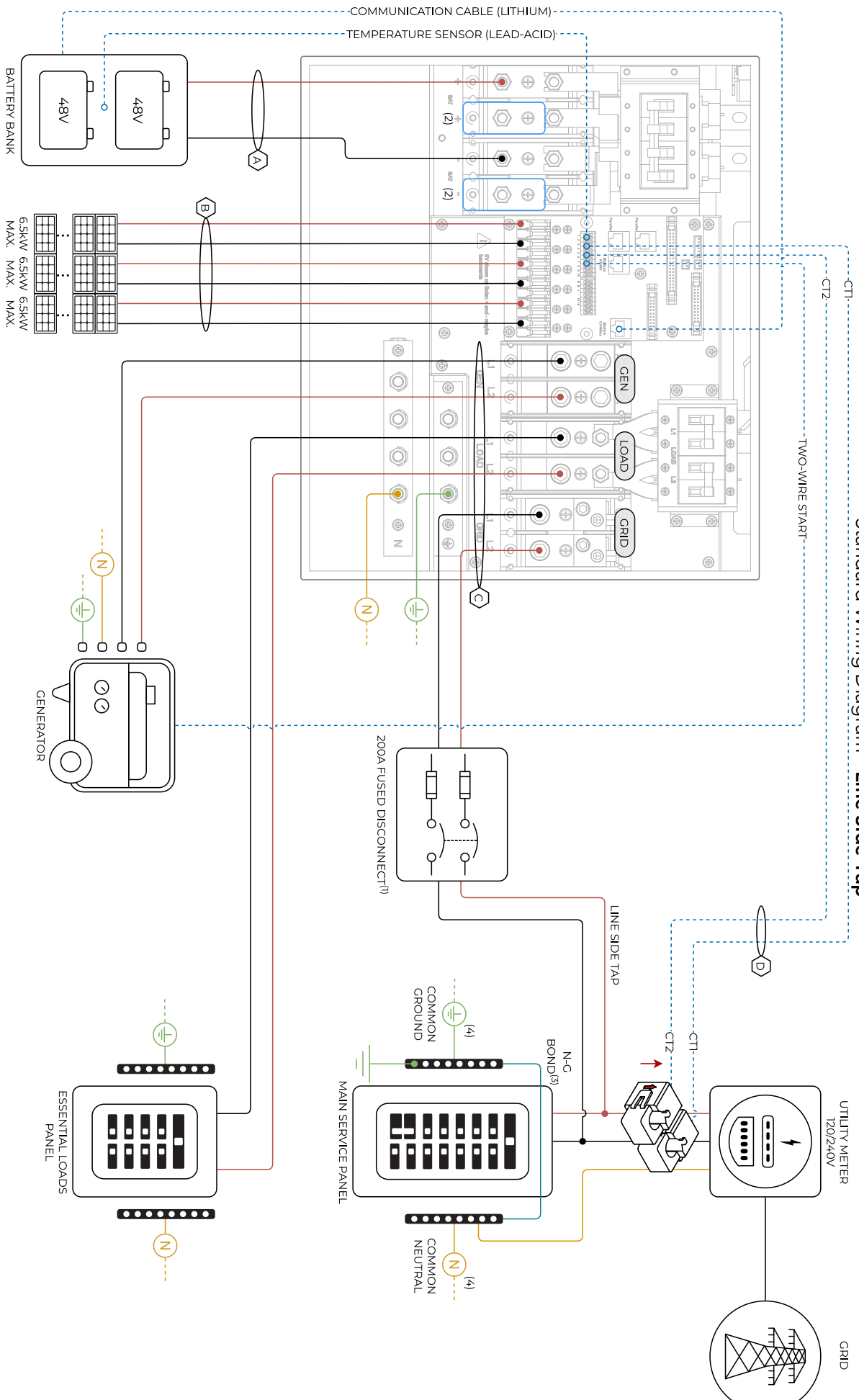

Diagram 01

### Standard Wiring Diagram - Line Side Tap



— 1- (AC) NEGATIVE - (DC)  
— 12 - (AC) POSITIVE - (DC)  
— NEUTRAL  
— GROUND  
- - - SENSORS / COMMUNICATIONS

- (1) SIZE OF DISCONNECT WILL DEPEND ON REQUIRED PASSTHROUGH CURRENT AND LOCAL CODE REQUIREMENTS
- (2) GREATER THAN 160A BATTERY CHARGE / DISCHARGE: REFER TO "MULTI-TERMINAL INSTALLATION" INSTRUCTIONS OF SECTION 2.2 ON LOCAL CODE
- (3) LOCATION OF THE NEUTRAL-GROUND BOND WILL DEPEND ON LOCAL CODE
- (4) THESE SYMBOLS REPRESENT A COMMON NEUTRAL / GROUND CONNECTION. **DO NOT** CONFUSE WITH GROUNDING ROD

WIRE GAUGE GUIDE (COPPER)

| LABEL | CONDUCTOR       |
|-------|-----------------|
| A     | MAX. 4/0 AWG    |
| B     | MAX. 10 AWG     |
| C     | MAX. 4/0 AWG    |
| D     | 24 -23 AWG CAT5 |

Diagram 02



# Standard Wiring Diagram - AC Coupling in GEN

Sol-Ark 15K-2P-N

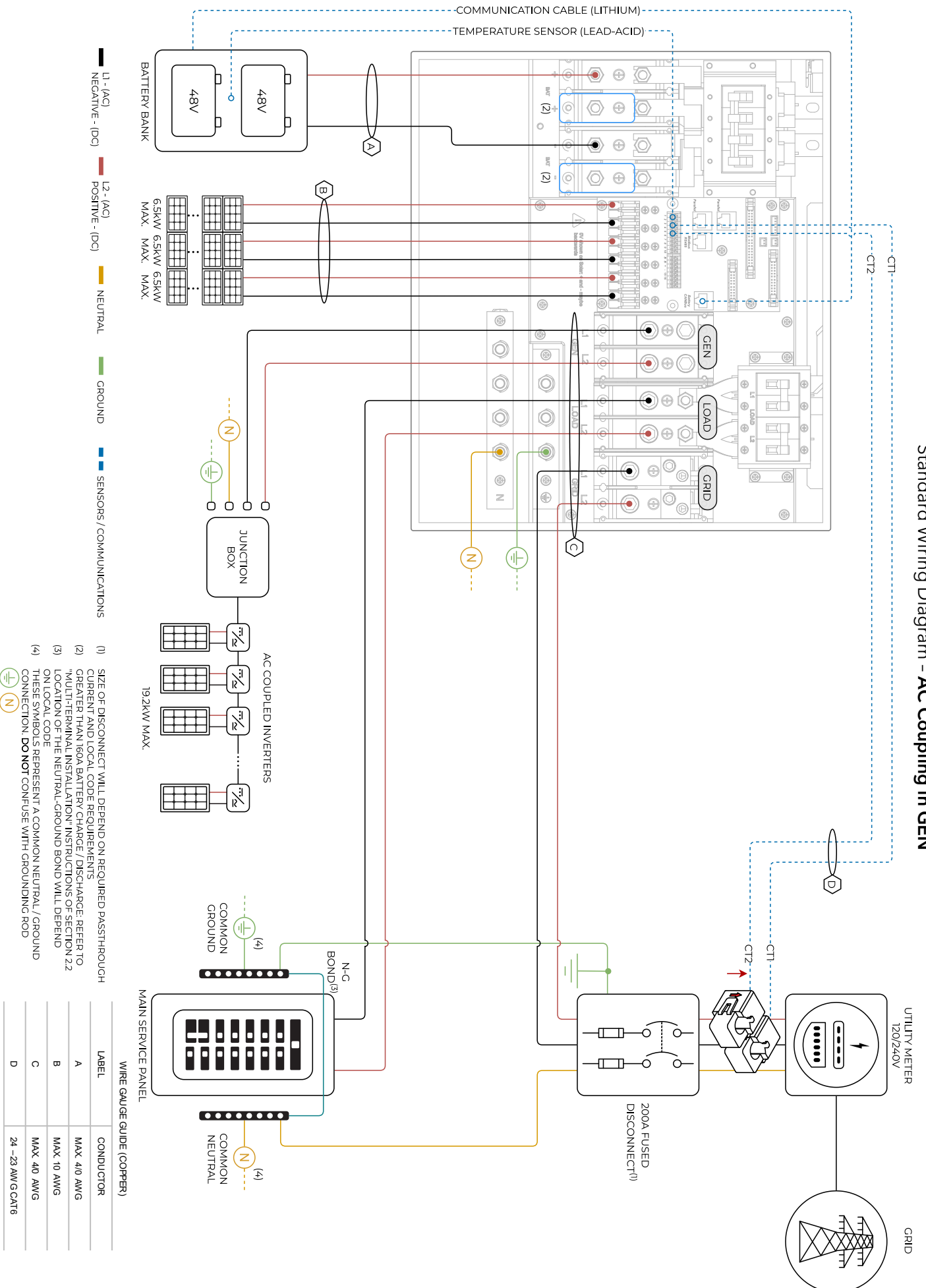
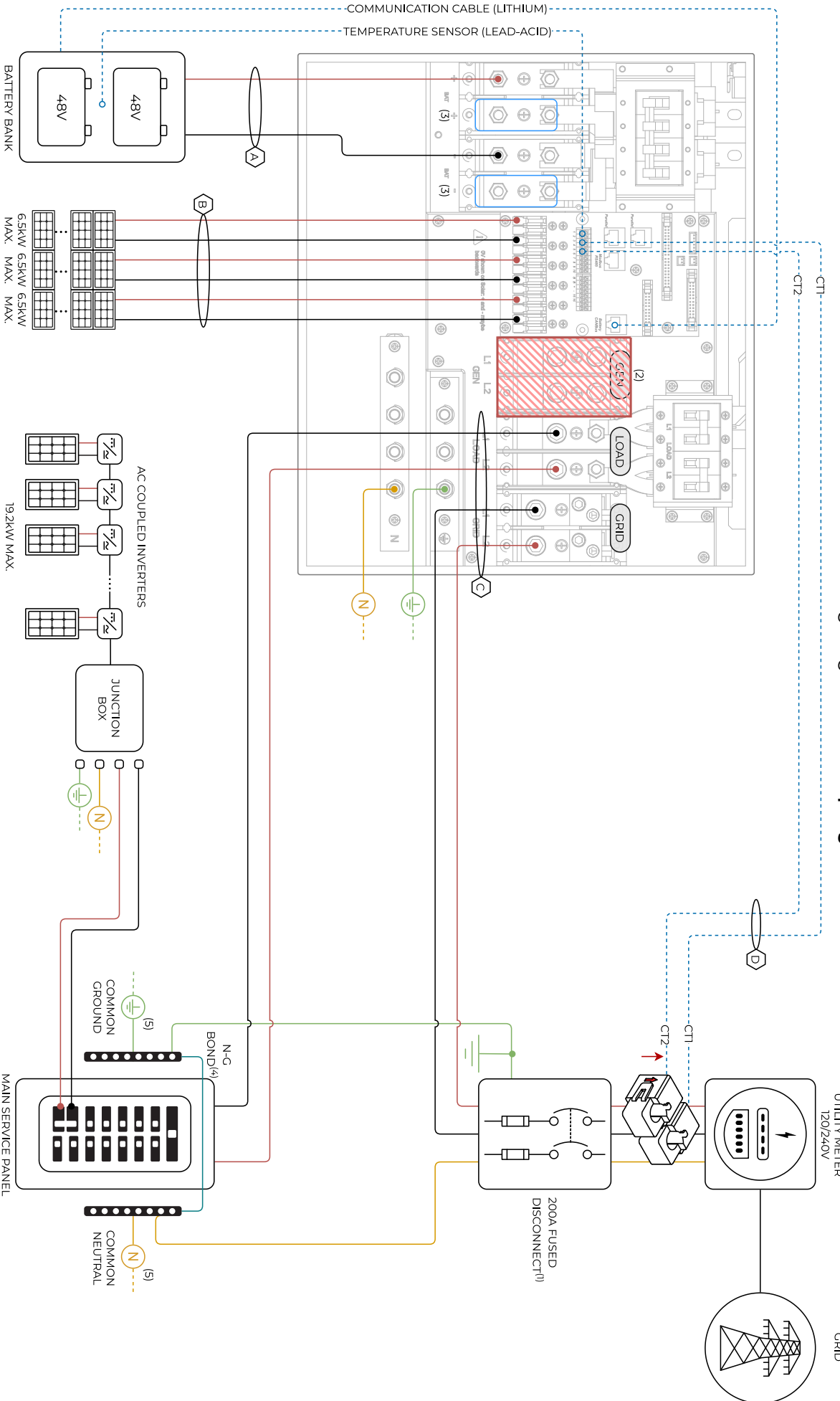

Diagram 03

# Standard Wiring Diagram – AC Coupling in LOAD

Sol-Ark 15K-2P-N



— L1 - (AC) NEGATIVE - (DC)  
— L2 - (AC) POSITIVE - (DC)  
— NEUTRAL  
— GROUND  
— SENSORS / COMMUNICATIONS

- (1) SIZE OF DISCONNECT WILL DEPEND ON REQUIRED PASSTHROUGH CURRENT AND LOCAL CODE REQUIREMENTS
- (2) "CEN" TERMINAL CANNOT BE USED
- (3) GREATER THAN 160A BATTERY CHARGE / DISCHARGE: REFER TO "MULTI-TERMINAL INSTALLATION" INSTRUCTIONS OF SECTION 2.2
- (4) LOCATION OF THE NEUTRAL-GROUND BOND WILL DEPEND ON LOCAL CODE
- (5) THESE SYMBOLS REPRESENT A COMMON NEUTRAL / GROUND CONNECTION. **DO NOT** CONFUSE WITH GROUNDING ROD

| WIRE GAUGE GUIDE (COPPER) |                 |
|---------------------------|-----------------|
| LABEL                     | CONDUCTOR       |
| A                         | MAX. 4/0 AWG    |
| B                         | MAX. 10 AWG     |
| C                         | MAX. 4/0 AWG    |
| D                         | 24 -23 AWG CAT6 |

Diagram 04

# Standard Wiring Diagram – Whole-Home Generator

Sol-Ark 15K-2P-N

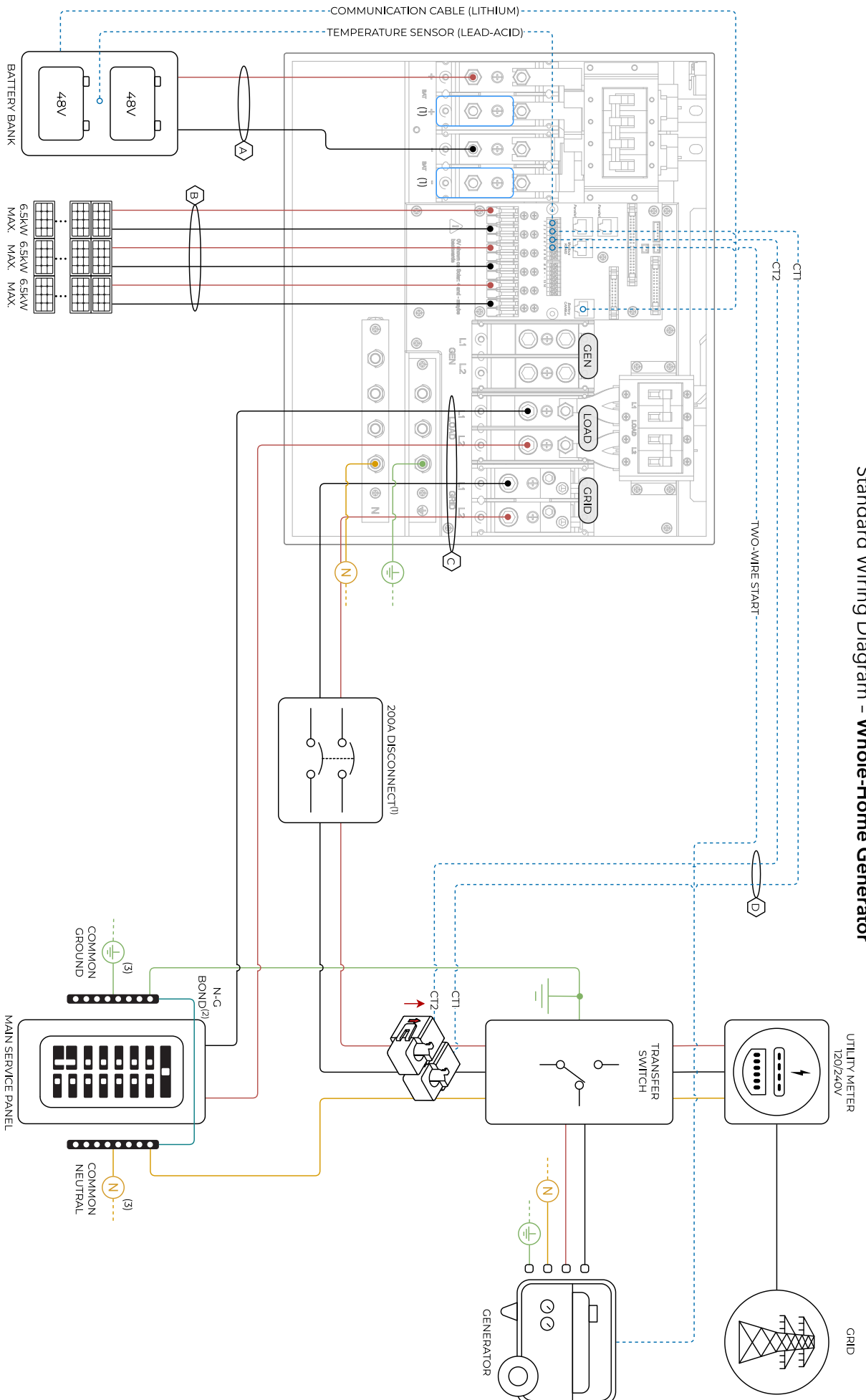

- L1 - (AC) NEGATIVE - (DC)
- L2 - (AC) POSITIVE - (DC)
- NEUTRAL
- GROUND
- SENSORS / COMMUNICATIONS

- (1) GREATER THAN 160A BATTERY CHARGE / DISCHARGE: REFER TO "MULTITERMINAL INSTALLATION" INSTRUCTIONS OF SECTION 2.2
- (2) LOCATION OF THE NEUTRAL-GROUND BOND WILL DEPEND ON LOCAL CODE
- (3) THESE SYMBOLS REPRESENT A COMMON NEUTRAL / GROUND CONNECTION. **DO NOT** CONFUSE WITH GROUNDING ROD

WIRE GAUGE GUIDE (COPPER)

| LABEL | CONDUCTOR      |
|-------|----------------|
| A     | MAX. 4/0 AWG   |
| B     | MAX. 10 AWG    |
| C     | MAX. 4/0 AWG   |
| D     | 24-23 AWG CAT6 |

Diagram 05

# Standard Wiring Diagram - Off Grid

Sol-Ark 15K-2P-N

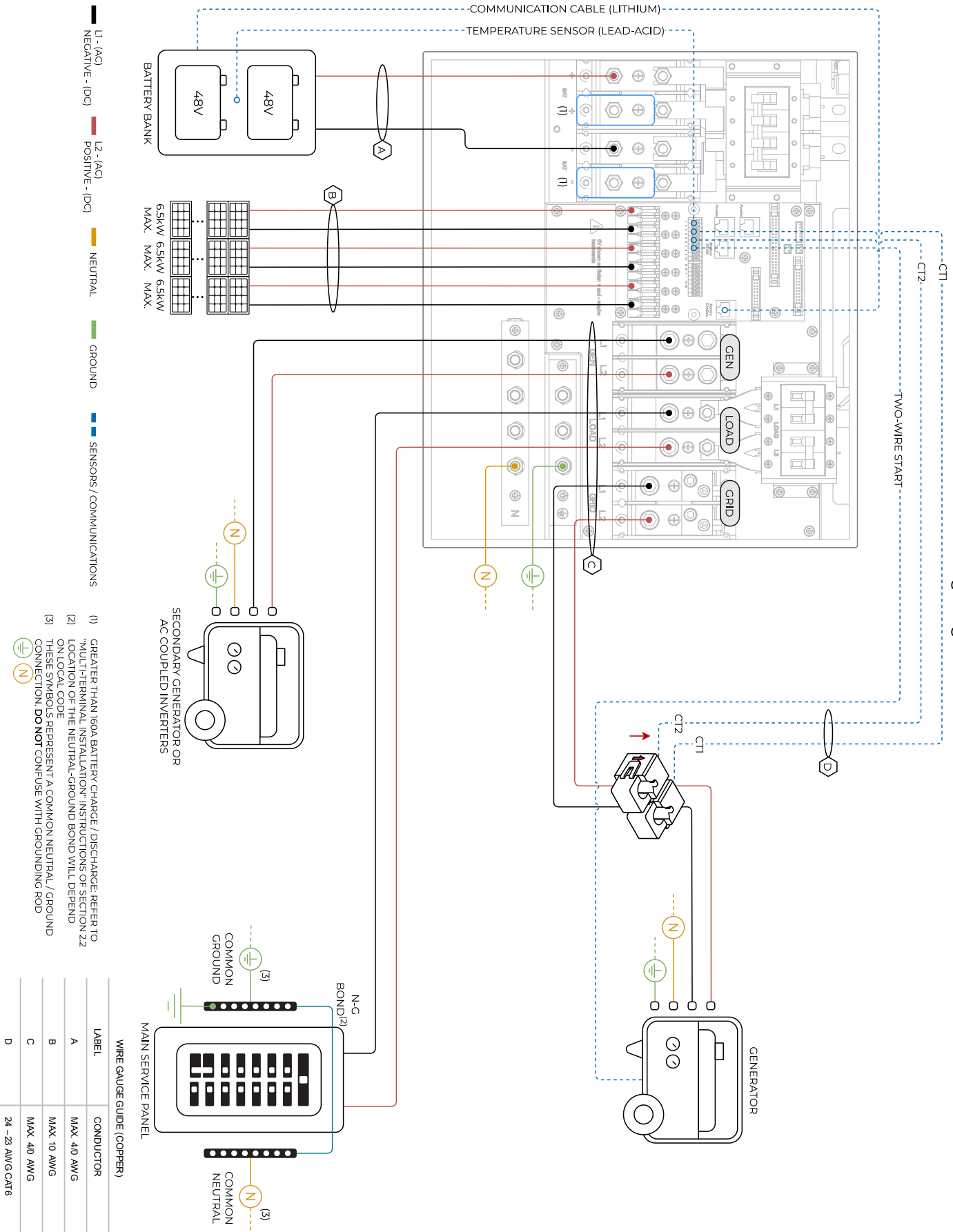

— L1-(AC) NEGATIVE - (DC)   
 — L2-(AC) POSITIVE - (DC)   
 — NEUTRAL   
 — GROUND   
 — SENSORS/ COMMUNICATIONS

- (1) GREATER THAN 160A BATTERY CHARGE / DISCHARGE: REFER TO "MULTI-TERMINAL INSTALLATION" INSTRUCTIONS OF SECTION 2.2 ON LOCAL CODE
- (2) LOCATION OF THE NEUTRAL-GROUND BOND WILL DEPEND ON LOCAL CODE
- (3) THESE SYMBOLS REPRESENT A COMMON NEUTRAL / GROUND CONNECTION. **DO NOT** CONFUSE WITH GROUNDING ROD

| WIRE GAUGE GUIDE (COPPER) |                  |
|---------------------------|------------------|
| LABEL                     | CONDUCTOR        |
| A                         | MAX. 4/0 AWG     |
| B                         | MAX. 10 AWG      |
| C                         | MAX. 4/0 AWG     |
| D                         | 24 - 23 AWG CAT6 |

Diagram 06

# Standard Wiring Diagram - Bypass Transfer Switch

Sol-Ark 15K-2P-N

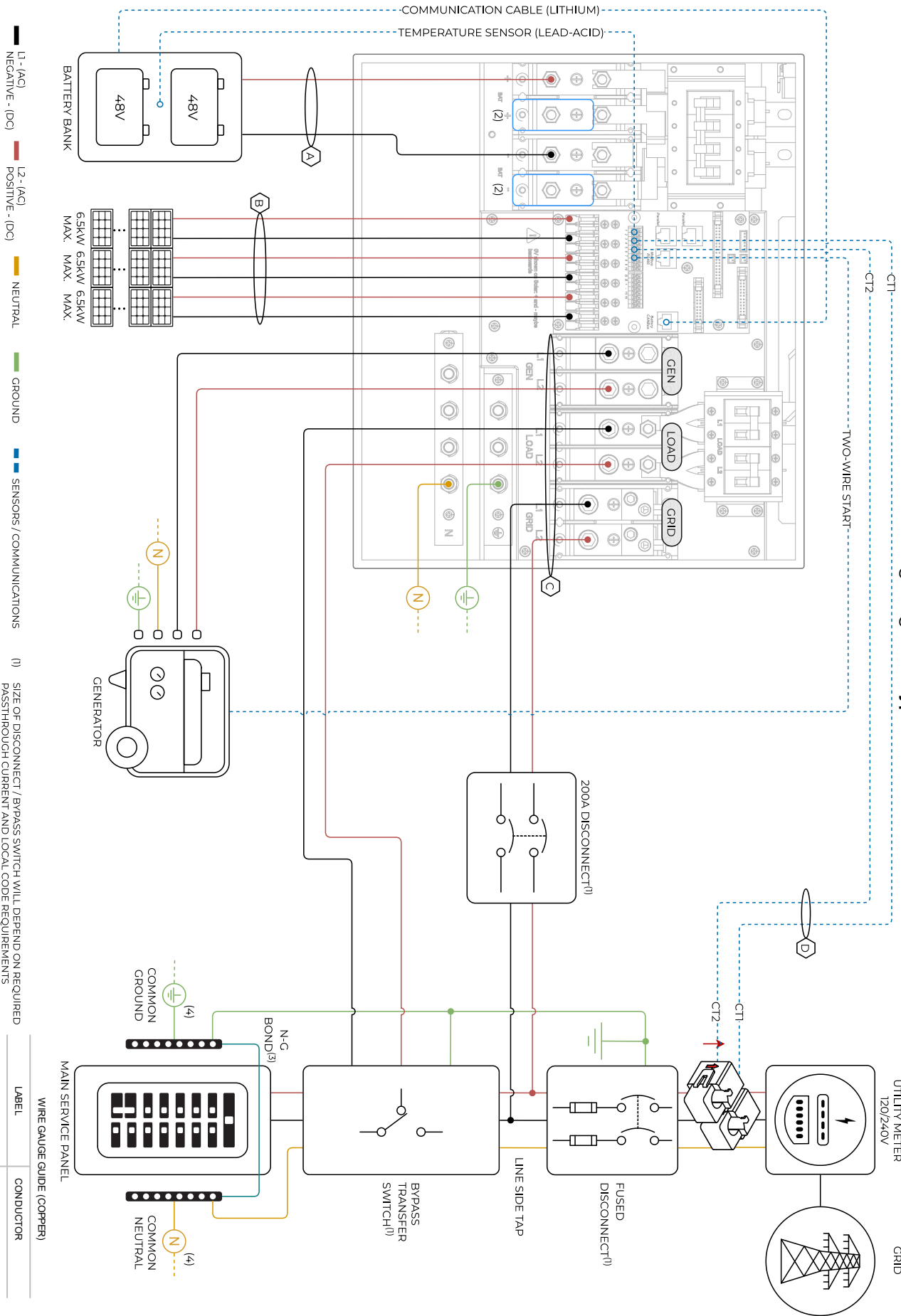

- (1) SIZE OF DISCONNECT / BYPASS SWITCH WILL DEPEND ON REQUIRED PASSES THROUGH CURRENT AND LOCAL CODE REQUIREMENTS. GREATER THAN 100A BATTERY CHARGE / DISCHARGE: REFER TO "MULTI-TERMINAL INSTALLATION" INSTRUCTIONS OF SECTION 2.2
- (2) "MULTI-TERMINAL INSTALLATION" INSTRUCTIONS OF SECTION 2.2 ON LOCAL CODE
- (3) LOCATION OF THE NEUTRAL-GROUND BOND WILL DEPEND ON LOCAL CODE
- (4) THESE SYMBOLS REPRESENT A COMMON NEUTRAL / GROUND CONNECTION. **DO NOT** CONFUSE WITH GROUNDING ROD

| WIRE GAUGE GUIDE (COPPER) | CONDUCTOR         |
|---------------------------|-------------------|
| A                         | MAX. 4/0 AWG      |
| B                         | MAX. 10 AWG       |
| C                         | MAX. 4/0 AWG      |
| D                         | 24 - 23 AWG CAT 6 |

Diagram 07

# Sol-Ark 15K-2P-N Standard Wiring Diagram - 2 Parallel Inverters | 120/240V

Sol-Ark 15K-2P-N

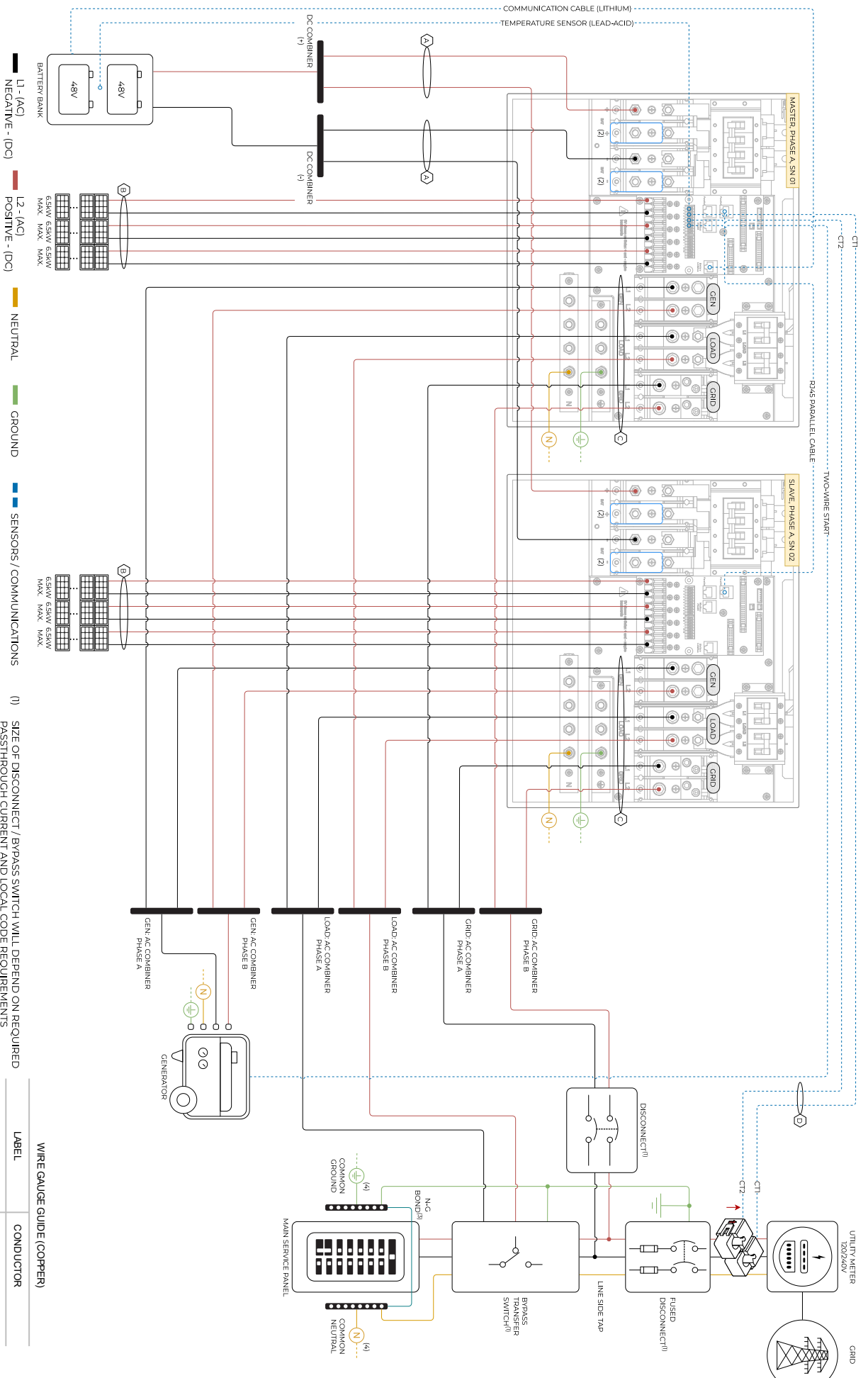

1-1 (AC)  
NEGATIVE - (DC)

1-2 (AC)  
POSITIVE - (DC)

NEUTRAL

GROUND

SENSORS / COMMUNICATIONS

- (1) SIZE OF DISCONNECT / BYPASS SWITCH WILL DEPEND ON REQUIRED PASTTHROUGH CURRENT AND LOCAL CODE REQUIREMENTS GREATER THAN 160A BATTERY CHARGE / DISCHARGE. REFER TO "MULTI-TERMINAL INSTALLATION" INSTRUCTIONS OF SECTION 2.2
- (2) LOCATION OF THE NEUTRAL-GROUND BOND WILL DEPEND ON LOCAL CODE
- (3) THESE SYMBOLS REPRESENT A COMMON NEUTRAL / GROUND CONNECTION. **DO NOT** CONFUSE WITH GROUNDING ROD
- (4)

WIRE GAUGE GUIDE (COPPER)

| LABEL | CONDUCTOR        |
|-------|------------------|
| A     | MAX. 4/0 AWG     |
| B     | MAX. 10 AWG      |
| C     | MAX. 4/0 AWG     |
| D     | 24 - 23 AWG CAT6 |

Diagram 08

**!** Before powering up Parallel System installs, please see section 5 "Parallel Systems"

# Sol-Ark 15K-2P-N Standard Wiring Diagram - 3 Parallel Inverters | 120/240V

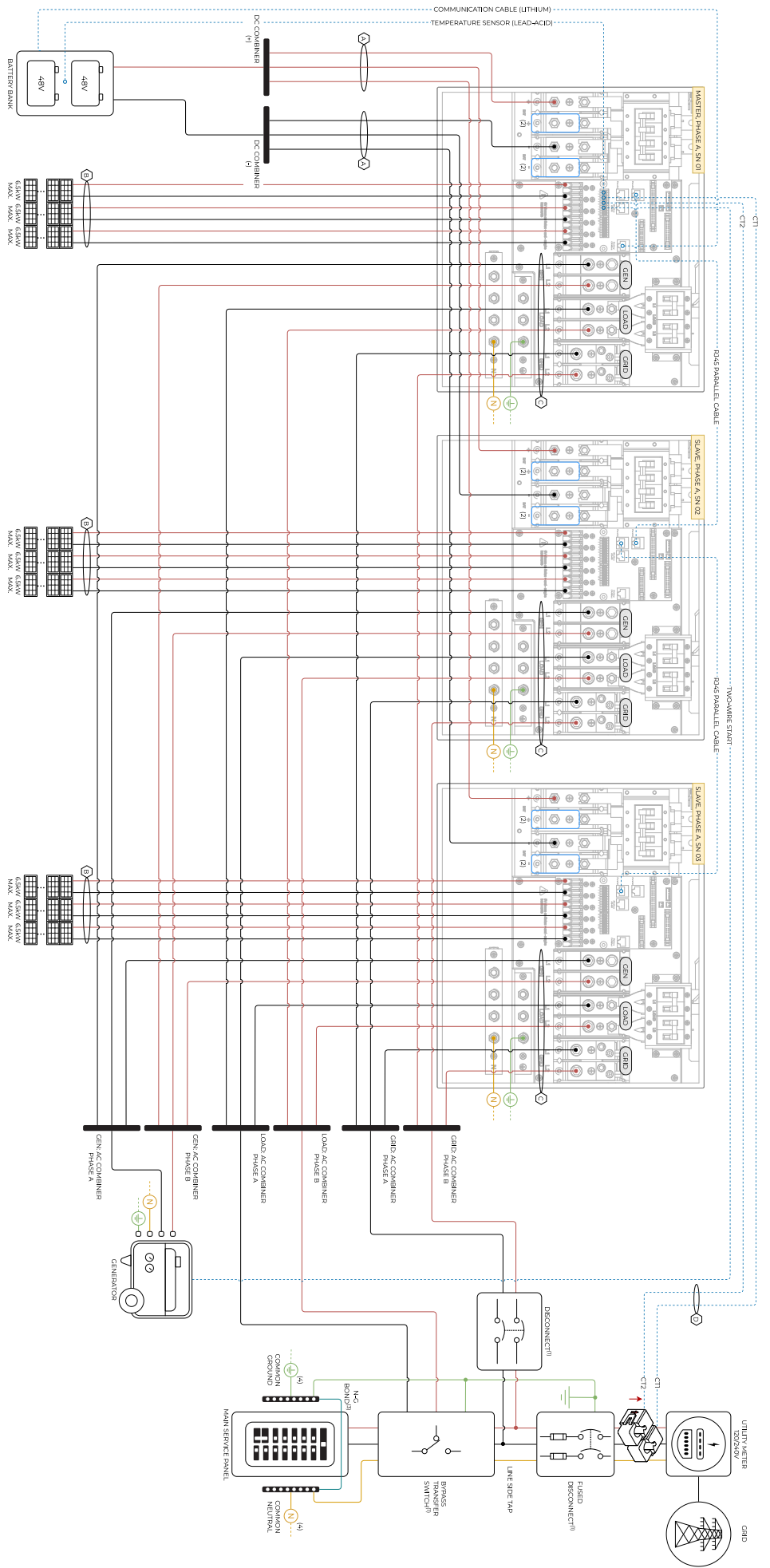

- L1 - (AC) NEGATIVE - (DC)
- L2 - (AC) POSITIVE - (DC)
- NEUTRAL
- GROUND
- SENSORS / COMMUNICATIONS

- (1) SIZE OF DISCONNECT / BYPASS SWITCH WILL DEPEND ON REQUIRED PASSTHROUGH CURRENT AND LOCAL CODE REQUIREMENTS
- (2) GREATER THAN 160A BATTERY CHARGE / DISCHARGE: REFER TO "MULTI-TERMINAL INSTALLATION" INSTRUCTIONS OF SECTION 2.2
- (3) LOCATION OF THE NEUTRAL-GROUND BOND WILL DEPEND ON LOCAL CODE
- (4) THESE SYMBOLS REPRESENT A COMMON NEUTRAL / GROUND CONNECTION. **DO NOT** CONFUSE WITH GROUNDING ROD

| WIRE GAUGE GUIDE (COPPER) |                 |
|---------------------------|-----------------|
| LABEL                     | CONDUCTOR       |
| A                         | MAX. 4/0 AWG    |
| B                         | MAX. 10 AWG     |
| C                         | MAX. 4/0 AWG    |
| D                         | 24 -23 AWG CAT6 |

**Diagram 09**  
*Before powering up Parallel System installs, please see section 5 "Parallel Systems"*

# Standard Wiring Diagram - 2 Parallel Inverters | 120/208V

Sol-Ark 15K-2P-N

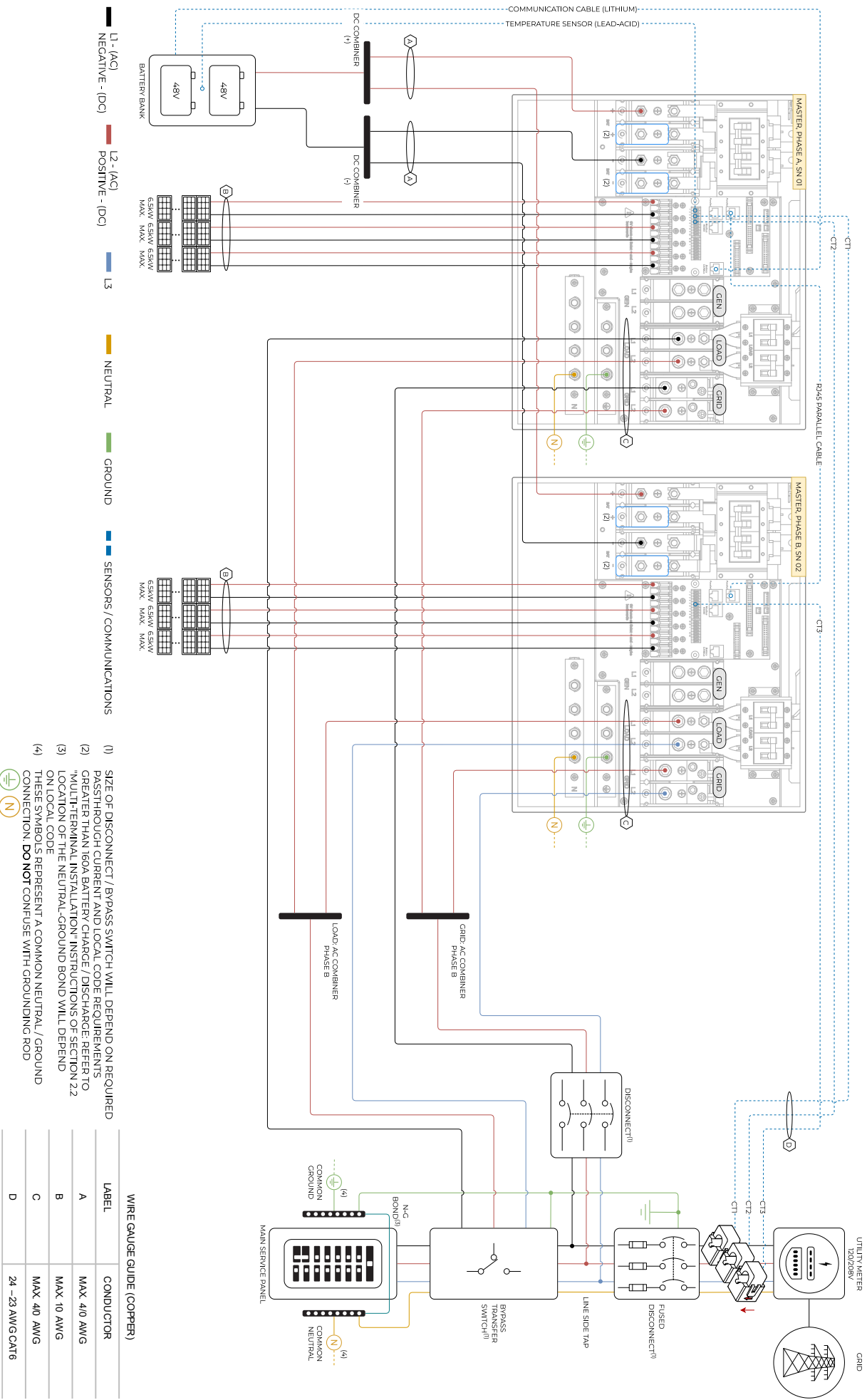

- (1) SIZE OF DISCONNECT / BYPASS SWITCH WILL DEPEND ON REQUIRED PASTTHROUGH CURRENT AND LOCAL CODE REQUIREMENTS
- (2) GREATER THAN 160A BATTERY CHARGE / DISCHARGE: REFER TO "MULTI-TERMINAL INSTALLATION" INSTRUCTIONS OF SECTION 2.2 ON LOCAL CODE
- (3) LOCATION OF THE NEUTRAL-GROUND BOND WILL DEPEND ON LOCAL CODE
- (4) THESE SYMBOLS REPRESENT A COMMON NEUTRAL / GROUND CONNECTION. **DO NOT** CONFUSE WITH GROUNDING ROD

**WIRE GAUGE GUIDE (COPPER)**

| LABEL | CONDUCTOR       |
|-------|-----------------|
| A     | MAX. 4/0 AWG    |
| B     | MAX. 10 AWG     |
| C     | MAX. 4/0 AWG    |
| D     | 24 -23 AWG CAT6 |

Diagram 10

**!** Before powering up Parallel System installs, please see section 5 "Parallel Systems"



Sol-Ark 15K-2P-N  
 Standard Wiring Diagram - 3 Parallel Inverters | 120/208V

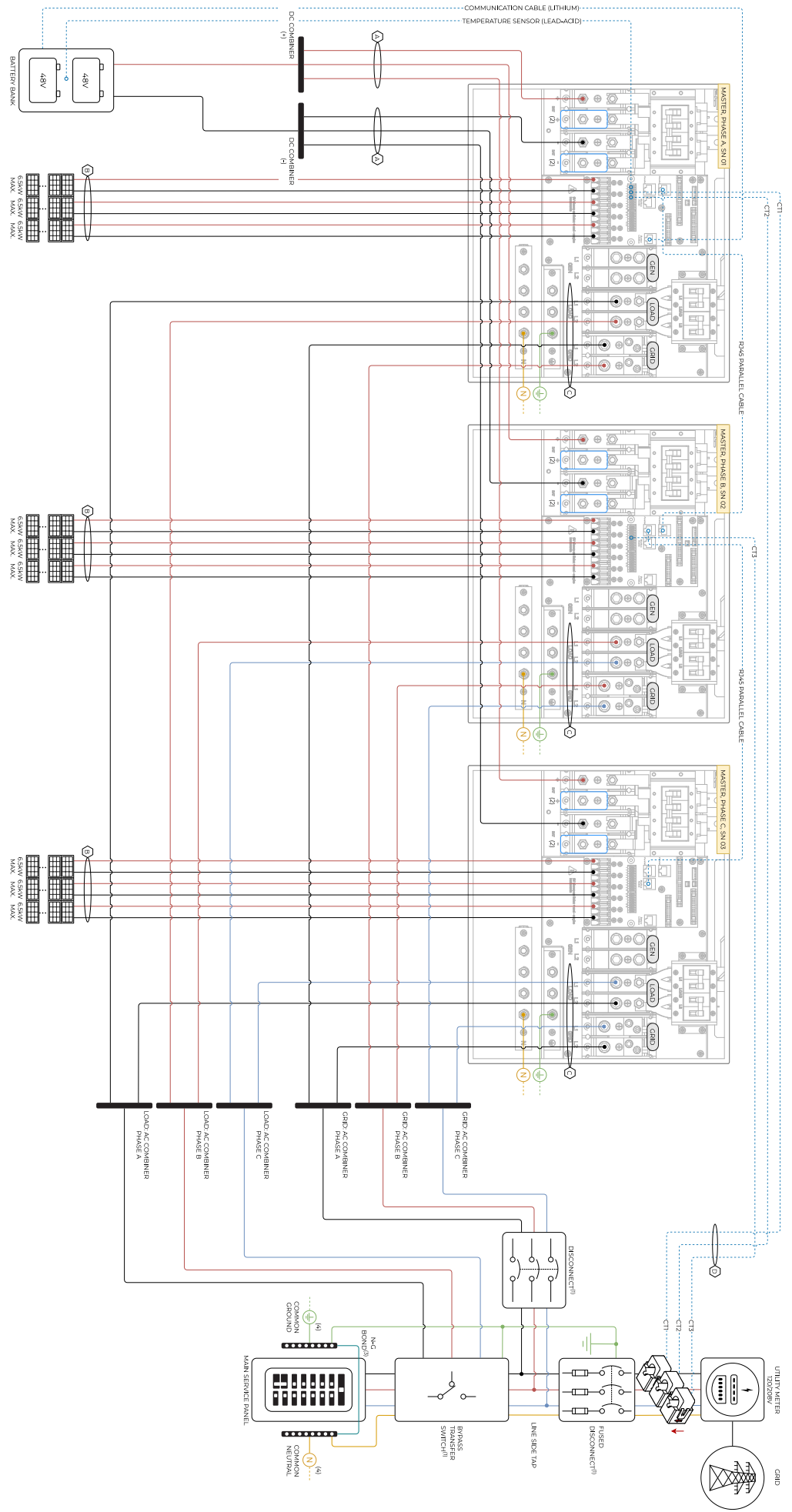

— L1 - (AC) NEGATIVE - (DC)  
— L2 - (AC) POSITIVE - (DC)  
— L3  
— NEUTRAL  
— GROUND  
— SENSORS / COMMUNICATIONS

- (1) SIZE OF DISCONNECT / BYPASS SWITCH WILL DEPEND ON REQUIRED PASTHROUGH CURRENT AND LOCAL CODE REQUIREMENTS GREATER THAN 160A BATTERY CHARGE / DISCHARGE: REFER TO "MULTI-TERMINAL INSTALLATION" INSTRUCTIONS OF SECTION 2.2
- (2) LOCATION OF THE NEUTRAL-GROUND BOND WILL DEPEND ON LOCAL CODE
- (3) THESE SYMBOLS REPRESENT A COMMON NEUTRAL / GROUND CONNECTION. **DO NOT** CONFUSE WITH GROUNDING ROD
- (4) THESE SYMBOLS REPRESENT A COMMON NEUTRAL / GROUND CONNECTION. **DO NOT** CONFUSE WITH GROUNDING ROD

| WIRE GAUGE GUIDE (COPPER) |                  |
|---------------------------|------------------|
| LABEL                     | CONDUCTOR        |
| A                         | MAX. 4/0 AWG     |
| B                         | MAX. 10 AWG      |
| C                         | MAX. 4/0 AWG     |
| D                         | 24 - 23 AWG CAT6 |

Diagram 11

**!** Before powering up Parallel System installs, please see section 5 "Parallel Systems"

## 8. Troubleshooting Guide

### LCD is not powering on

- Check all connections - at least one of the following power sources is required: PV/Grid/Battery
- Try pressing the power button, touchscreen, or navigation buttons

### Panels are connected, but "DC" LED indicator is not on

- Minimum starting voltage is 125V. Voltage must be above 125V and below 500V
- Wrong polarity. Check string polarity on MPPT
- PV DC disconnect is not on the ON position

### Panels are not producing

- Check for proper wiring on all solar panel connections
- Turn PV disconnect "ON"
- Check that the PV input voltage is not greater than 500V
- If the system measures 0V even when PV DC disconnect is ON, polarity might be wrong. Check PV polarity

### Panels are not producing much power

- PV Wire Strip Length: 5/8". Your batteries are charged and is limited to house loads; you can test Grid Sell to verify.

### The system does not keep batteries charged

- Check the charge setting in the Charge Menu

### Auto Gen-Start is not working

- Check to make sure your generator is compatible with Auto Start
- Make sure that the Auto Gen Start wire is adequately connected to the Sol-Ark 15K and the generator

### "Normal" LED indicator is not on

- Sol-Ark is in pass-through-only mode, only a Grid connection
- Not fully energized (DC Solar panels AND Grid or just batteries)
- In alarm state.
- Sol-Ark is not working correctly (Call technical support +1 (972) 575-8875 Ext. 2)

### The "Alarm" LED indicator is on

- Check the system alarms menu to identify the alarm

### Grid HM value is negative when it should be positive (only applies in Limited to Home mode)

- Limiter Sensors are backwards, L1/L2 sensors are swapped, or incorrectly wired L1/L2 sensors. Execute the "Auto Learn Home Limit Sensors" command described in section 2.8 "Limit Sensors, Automatic CT Limit Sensors Configuration"

### AC Overload Fault or Bus Unbalance Fault

- Check Transfer Switch/Subpanel wiring
- Check for large loads that consume more than the inverter rating (EX: AC units over 3 tons)

### The system connects to grid and quickly disconnects

- Verify your Neutral wire connection (should be 0Vac referenced to GND)
- Check your Freq is set to 60Hz, and the 15K measures 120V on L1 vs. N / L2 vs. N
- If overloading: verify 120V/240V grid input and load output wires are not swapped

### DC Overload Fault

- Check PV voltage
- Make sure you have not wired more than two (2) solar strings in parallel per MPPT

### System is beeping

- Check the System Alarms menu to see which alarm has been triggered. Most alarms will self-reset.
- There is no battery connected. If not using a battery, select "No Battery" and disable "Activate Batt" in Batt menu.
- Execute a Power Cycle

---

### Battery cable sparks when connected

- If applicable, flip the built-in breaker of the battery to the OFF position before connecting or disconnecting batteries.

### Battery symbol on the home screen is red

- The battery is below the empty voltage
- Battery is over-voltage

### Battery symbol on the home screen is yellow

- The battery is low, or the charge/discharge current is close to the programmed limit

### Grid symbol on the home screen is yellow

- Grid parameters are out of specified operating range
- There is a grid outage and there is no voltage on the GRID terminals
- System is Off-Grid

### System has restarted

- Occurs if the system is overloaded, battery voltage is greater than 63V, or Software update

### Batteries were connected backwards

-  System will be damaged, and warranty will be lost

### Why is the LCD screen still on when the power button is off?

- If PV or Grid power is connected, LCD stays on, but the inverter and loads are off

### The Batt SOC% is not reaching 100%

- The Sol-Ark might be in the calibration phase and estimating the battery SOC. We suggest waiting three full days to let the unit go through the 4-stage charging curve to converge to an accurate %
- If the suggestion above does not work, you can re-adjust the battery capacity under "Battery Setup" → "Batt Capacity" to restart the calibration process

### Generator setup is reading 0Hz

- Generator frequency is out of frequency range. Select "General Standard" instead of UL1741. Then widen the frequency range to 55Hz-65Hz

### Color Touchscreen is Frozen

- Press and hold the escape button [◀] for 7-10 seconds
- Perform a power cycle sequence in case the above suggestion does not work. See section 2.11 "Power Cycle Sequence"

## 8.1 Sol-Ark Error codes

| FAULT | INSTRUCTION                | COMMON CAUSE / REMEDY  |
|-------|----------------------------|--|
| F1    | DC_Inversed_Failure        | If you have parallel systems and turn one system off, you will get this notification. <b>NOT</b> a fault.  |
| F8    | GFDI_Relay_Failure         | Check for continuity on the inverter's neutral and ground. Ensure there is only ONE neutral-to-ground bond in the system. Current Leakage from inverter AC output to Ground, check Ground and neutral are connected at the main panel. |
| F13   | Grid_Mode_change           | It can happen when not using batteries or if Grid Input settings are changed. This is a notification, <b>NOT</b> a fault. If you switch from No Batt to Battery mode, power the system down completely to restart.                     |
| F15   | AC_OverCurr_Failure        | It is usually caused by Loads too large for the inverter. If Off-Grid, the battery discharge Amps are programmed too low. Overloads can result in F15, F18, F20, or F26.   |
| F16   | GFCI_Failure               | Ground fault. Check PV+ or PV- wiring (which must be ungrounded). Exposed PV conductors + rain can also cause. Check that the neutral line and Ground are not double-bonded (common with portable generators).                         |
| F18   | Tz_AC_OverCurr_Fault       | Overloaded the Load Output (reduce loads) or overloaded a generator (reduce Gen Start A). Wiring Short on the AC Side can also cause this error. Overloads can result in F15, F18, F20, or F26.  |
| F20   | Tz_Dc_OverCurr_Fault       | It is typically caused by DC current from the battery that is too large (ex: 4 Ton AC Unit) or too much PV current (3 or more strings in parallel). Overloads can result in F15, F18, F20, or F26.                                     |
| F22   | Tz_EmergStop_Fault         | Initiated Emergency Stop; see sensor pinout table.   |
| F24   | DC_Insulation_Fault        | An exposed PV conductor combined with moisture is faulting (can cause F16, F24, and F26).  |
| F25   | DC_Feedback_Fault          | No battery connection to the Inverter and Activate Battery is enabled. Disable Activate Battery in settings while no battery is connected.   |
| F26   | BusUnbalance_Fault         | Too much load on one leg (L1 or L2) vs. the other leg or DC loads on the AC output when Off-Grid. Grounded PV+/- wire can cause F20, F23, or F26.  |
| F29   | Parallel_CANBus_Fault      | Usually, a communication error for parallel systems. Check cables, and MODBUS addresses.   |
| F31   | Soft_Start_Failed          | Soft Start of the large motor failed.  |
| F34   | AC_Overload_Fault          | AC Overload or load shorted. Reduce heavy loads.   |
| F35   | AC_NoUtility_Fault         | Grid connection lost.  |
| F37   | DCLLC_Soft_Over_Cur        | Software DC overcurrent.   |
| F39   | DCLLC_Over_Current         | Hardware DC overcurrent.   |
| F40   | Batt_Over_Current          | Batteries exceeded their current discharge limit.  |
| F41   | Parallel_System_Stop_Fault | If one system faults in parallel, this normal fault will register on the other units as they disconnect from the grid.   |
| F45   | AC_UV_OverVolt_Fault       | Grid under voltage causes a disconnect. This will self-reset when the grid stabilizes.   |
| F46   | Battery_Backup_Fault       | Cannot communicate with other parallel systems. Check Master = 1, Slaves = 2-9 and that ethernet are connected.  |
| F47   | AC_OverFreq_Fault          | Grid over Frequency (common in power outages) causes disconnect. Will self-reset when grid stabilizes.   |
| F48   | AC_UnderFreq_Fault         | Grid under Frequency (common in power outages) causes a disconnect. Will self-reset when grid stabilizes.  |
| F55   | DC_VoltHigh_Fault          | PV may be higher than 500V. Battery voltage should not be above 59V or 63V (depending on the model).   |
| F56   | DC_VoltLow_Fault           | Batteries are overly discharged, the inverter is Off-Grid and exceeded the programmed batt discharge current by 20%, or Lithium BMS has shut down. If battery settings are incorrect, this can also happen.                            |
| F58   | BMS_Communication Fault    | Sol-Ark is programmed to BMS Lithium Battery Mode but cannot communicate with a BMS. BMS_Err_Stop is enabled, but cannot communicate with a battery BMS  |
| F60   | Gen_Volt_or_Fre_Fault      | Generator Voltage or Frequency went outside the allowable range.   |
| F61   | Button_Manual_OFF          | The parallel Slave system turned off without turning off the Master.   |
| F63   | Arc_Fault                  | It can be a poor PV connector / Connection. Or sometimes a false alarm due to powerful lightning storms.   |
| F64   | Heatsink_HighTemp_Fault    | Check that the built-in fans are running; the ambient temperature may be too high. Ensure proper clearance.  |

# 9. Install Verification

## 9.1 Warranty Checklist

**The installer must complete this form AFTER the system is operational**



This checklist must be filled out and submitted to register your warranty. Please visit:  
<https://www.sol-ark.com/register-your-sol-ark/>

|  |       |
|--|-------|
| 1. Have you sent a wiring diagram of your installation to Sol-Ark for verification? ( <a href="mailto:support@sol-ark.com">support@sol-ark.com</a> )   | Y / N |
| a. If not, Sol-Ark assumes no responsibility for any performance issues as a result of the installation. Sol-Ark is not responsible for any changes to the installation.   |       |
| 2. Is the inverter installed in a location where the LCD screen is protected from direct sunlight and is there enough vertical and lateral clearance for proper heat dissipation?  | Y / N |
| 3. Are all the battery lugs properly tightened at the corresponding torque? (90 in-lb / 10 Nm)   | Y / N |
| 4. Based on the following checklist: <input type="checkbox"/> grid or generator connected   <input type="checkbox"/> load panel(s) connected   <input type="checkbox"/> "LOAD" and "GRID" terminals ON   <input type="checkbox"/> batteries ON   <input type="checkbox"/> PV DC disconnect ON   <input type="checkbox"/> power button ON |       |
| a. Did any breakers trip?  | Y / N |
| b. Did the inverter overload?  | Y / N |
| 5. If you are experimenting problems, email a description and photographs to <a href="mailto:support@sol-ark.com">support@sol-ark.com</a> including:   |       |
| a. Photograph of the "Details Screen" including the voltages measured by the inverter.   |       |
| b. Photographs of the Sol-Ark inverter, user wiring area and batteries.  |       |
| 6. Load and solar production TEST:<br>Press the battery icon to access the "Details Screen" and corroborate the following readings:  |       |
| a. In case of having lead-acid batteries, verify if the battery temperature sensor is measuring data.  | Y / N |
| b. Test the system by powering on considerable loads at the essential loads panel (backup circuits). Are the solar panels generating enough power to match the load demand (provided there is enough sun)?   | Y / N |
| c. Provided there is grid and excess solar production compared to load demand, enable " <input checked="" type="checkbox"/> Grid Sell" mode. Is the inverter selling power back to the grid? (Negative HM measurements for L1 and L2)  | Y / N |
| • Enable " <input checked="" type="checkbox"/> Limited Power to Home" mode ONLY. Are the HM measurements approximating zero or are slightly positive? Are they canceling out the grid demand (Meter Zero)?   | Y / N |
| • Have you verified that the limit sensors are correctly installed? The "Auto Detect Home Limit Sensors" function auto corrects mistakes in CT sensor wiring. Batteries are and 120/240V grid required. (See section 2.8 - "Automatic CT Limit Sensors Configuration" for details).  | Y / N |
| 7. Have you programed the correct capacity (Ah) for the battery bank and recommended Max A charge/discharge?   | Y / N |
| 8. Have you programed the recommended battery charge voltages from your battery manufacturer?  | Y / N |
| 9. Off-Grid TEST:  |       |
| a. Minding the max power output of the Sol-Ark, turn OFF the external AC grid disconnect so that the Sol-Ark operates in an Off-Grid mode. Are appliances still being powered?   | Y / N |
| b. Follow by turning OFF the PV DC disconnect, running only on batteries. Are appliances still being powered?  | Y / N |
| 10. Have you followed the steps for setting up the Wi-Fi / Ethernet connection and registered the customer's system on our monitoring app?   | Y / N |
| 11. Provided there is a standby or portable generator installed:   | Y / N |
| a. Have you programmed "General Standard" grid mode and reprogramed grid freq. range to 55-65Hz?   | Y / N |
| b. Have you enabled " <input checked="" type="checkbox"/> Gen Charge" and adequately set the charge current "A"(DC) at which the batteries will be charged from the generator?   | Y / N |
| 12. If the system has EMP protection, have you installed the included small suppressors on essential appliance cords and big suppressors on solar panel wires?   | Y / N |

\_\_\_\_\_  
Installer name

\_\_\_\_\_  
Installer Signature

\_\_\_\_\_  
Date

\_\_\_\_\_  
Customer Name

\_\_\_\_\_  
Customer Signature

\_\_\_\_\_  
Date

## 9.2 Limited Warranty: Sol-Ark 15K-2P-N

10-Year Limited Warranty for SOL-ARK (Portable Solar LLC) Products. Sol-Ark provides a Ten-year (10) limited Warranty ("Warranty") against defects in materials and workmanship for its Sol-Ark products ("Product"). The term of this warranty begins on the Product(s) initial purchase date, or the date of receipt of the Product(s) by the end user, whichever is later. This must be indicated on the invoice, bill of sale from your installer. This warranty applies to the original Sol-Ark Product purchaser and is transferable only if the Product remains installed in the original use location. Please call Sol-Ark to let us know if you are selling your Home and give us name and contact of the new owner.

The warranty does not apply to any Product or Product part that has been modified or damaged by the following:

- Installation or Removal (examples: wrong voltage batteries, connecting batteries backward, damage due to water/rain to electronics, preventable damage to solar wires.)
- Alteration or Disassembly.
- Normal Wear and Tear.
- Accident or Abuse.
- Unauthorized Firmware updates/software updates or alterations to the software code.
- Corrosion.
- Lightning: unless using EMP hardened system, then Portable Solar will repair the product.
- Repair or service provided by an unauthorized repair facility.
- Operation or installation contrary to manufacturer product instructions.
- Fire, Floods, or Acts of Nature.
- Shipping or Transportation.
- Incidental or consequential damage caused by other components of the power system.
- Any product whose serial number has been altered, defaced, or removed.
- Any other event not foreseeable by Portable Solar, LLC

Sol-Ark (Portable Solar LLC) liability for any defective Product, or any Product part, shall be limited to the repair or replacement of the Product, at Portable Solar LLC discretion. Sol-Ark does not warrant or guarantee workmanship performed by any person or firm installing its Products. This warranty does not cover the costs of installation, removal, shipping (except as described below), or reinstallation of Products or parts of Products. LCD screen and fans are covered for 5 years from date of purchase.

THIS LIMITED WARRANTY IS THE EXCLUSIVE WARRANTY APPLICABLE TO SOL-ARK (PORTABLE SOLAR LLC) PRODUCTS. SOL-ARK EXPRESSLY DISCLAIMS ANY OTHER EXPRESS OR IMPLIED WARRANTIES OF ITS PRODUCTS. SOL-ARK ALSO EXPRESSLY LIMITS ITS LIABILITY IN THE EVENT OF A PRODUCT DEFECT TO REPAIR OR REPLACEMENT IN ACCORDANCE WITH THE TERMS OF THIS LIMITED WARRANTY AND EXCLUDES ALL LIABILITY FOR INCIDENTAL OR CONSEQUENTIAL DAMAGES, INCLUDING WITHOUT LIMITATION ANY LIABILITY FOR PRODUCTS NOT BEING AVAILABLE FOR USE OR LOST REVENUES OR PROFITS, EVEN IF IT IS MADE AWARE OF SUCH POTENTIAL DAMAGES.

**Return Policy - No returns will be accepted without prior authorization** and must include the Return Material Authorization (RMA) number. Please call and talk to one of our engineers to obtain this number at 972-575-8875.

**Return Material Authorization (RMA) A request for an RMA number requires all the following information:** 1. Product model and serial number; 2. Proof-of-purchase in the form of a copy of the original Product purchase invoice or receipt confirming the Product model number and serial number; 3. Description of the problem; 4. Validation of problem by Technical Support, and 5. Shipping address for the repaired or replacement equipment. Upon receiving this information, the Sol-Ark representative can issue an RMA number. Any product that is returned must be brand new, in excellent condition and packaged in the original manufacturer's carton with all corresponding hardware and documentation. Returns must be shipped with prepaid freight and insured via the carrier of your choice to arrive back at Portable Solar within 30 days of your initial delivery or pick-up. **Shipping charges will not be refunded.** All returns are subject to a 35% restocking fee. **No returns will be accepted beyond 30 days of original delivery.** The value and cost of replacing any items missing (parts, manuals, etc.) will be deducted from the refund. If you have any questions regarding our return policy, please email us at [sales@sol-ark.com](mailto:sales@sol-ark.com) or call us at the number above during regular (M-F) business hours.

**Sol-Ark 15K-2P-N Install Operational Verification Checklist Questionnaire must be filled out, signed, and dated to secure full warranty coverage.**

Contact: (USA) 1-972-575-8875

For Info/Purchasing:

[sales@sol-ark.com](mailto:sales@sol-ark.com) | ext.1

For Tech Support/Warranty Claim:

[support@sol-ark.com](mailto:support@sol-ark.com) | ext.2

# 10. GUI Screens

## Main Menu

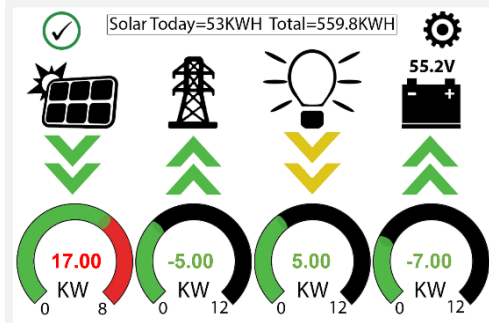

| Solar                     | Grid                          | INV                    | USP LD                          | Batt                                 |
|---------------------------|-------------------------------|------------------------|---------------------------------|--------------------------------------|
| 3882W                     | -3081W<br>60.0Hz              | 3702W<br>60.0Hz        | 621W<br>122V                    | -26W                                 |
| L1: 263V<br>5.4A<br>1398W | 126V<br>HM:-786W<br>LD:-1876W | 122V<br>15.2A<br>1857W | 0W<br>121V<br>640W              | 54.70V<br>-0.53A<br>25.0C            |
| L2: 264V<br>9.5A<br>2484W | 122V<br>HM:1142W<br>LD:1205W  | 121V<br>14.8A<br>1845W | <b>Gen</b><br>4V<br>0.0Hz<br>0W | <b>TEMP</b><br>DC: 55.0C<br>AC:49.7C |

System Setup 10/14/2022 03:05:27 PM Fri.

Basic Setup System Alarms

Battery Setup **Li-Batt Info**

Only w/ BMS Lithium Mode

Sol-Ark 5K/8K/12K/15K-P  
- ID: #####  
- COMM: ####  
- MCU: Ver####

System Alarms 1/25/2021 03:05:27 PM Mon.

| Alarms Code           | Occurred         |
|-----------------------|------------------|
| F13 Grid_Mode_changed | 2021-01-13 11:22 |
| F13 Grid_Mode_changed | 2021-01-13 11:20 |

| 0.00 V | 0.00 A | 0.0 C | 0% | 0 Ah      |
|--------|--------|-------|----|-----------|
| 0.0 V  | 0.0 V  | 0A    | 0A | 0x00 0x00 |

Only w/ BMS Lithium Mode

|                              |      |      |       |
|------------------------------|------|------|-------|
| 1. 0.00 V 0.00 A 0.0 C 0.0%  | 0.0V | 0.0A | 0 0 0 |
| 2. 0.00 V 0.00 A 0.0 C 0.0%  | 0.0V | 0.0A | 0 0 0 |
| 3. 0.00 V 0.00 A 0.0 C 0.0%  | 0.0V | 0.0A | 0 0 0 |
| 4. 0.00 V 0.00 A 0.0 C 0.0%  | 0.0V | 0.0A | 0 0 0 |
| 5. 0.00 V 0.00 A 0.0 C 0.0%  | 0.0V | 0.0A | 0 0 0 |
| 6. 0.00 V 0.00 A 0.0 C 0.0%  | 0.0V | 0.0A | 0 0 0 |
| 7. 0.00 V 0.00 A 0.0 C 0.0%  | 0.0V | 0.0A | 0 0 0 |
| 8. 0.00 V 0.00 A 0.0 C 0.0%  | 0.0V | 0.0A | 0 0 0 |
| 9. 0.00 V 0.00 A 0.0 C 0.0%  | 0.0V | 0.0A | 0 0 0 |
| 10. 0.00 V 0.00 A 0.0 C 0.0% | 0.0V | 0.0A | 0 0 0 |
| 11. 0.00 V 0.00 A 0.0 C 0.0% | 0.0V | 0.0A | 0 0 0 |
| 12. 0.00 V 0.00 A 0.0 C 0.0% | 0.0V | 0.0A | 0 0 0 |
| 13. 0.00 V 0.00 A 0.0 C 0.0% | 0.0V | 0.0A | 0 0 0 |

## Basic Setup

Basic Setup

Display Time Advanced Factory Reset Parallel

Brightness

Auto Dim  600S

Beep

CANCEL OK

Basic Setup

Display Time Advanced Factory Reset Parallel

AM/PM Year 2021 Month 10 Day 26

Time Sync PM Hour 03 Minute 04 Second 15

Seasons Start M-D Season1 1 - 1 Season2 4 - 1 Season3 8 - 1

End M-D 4 - 1 8 - 1 12 - 1

CANCEL OK

Basic Setup

Display Time Advanced Factory Reset Parallel

Solar Arc Fault ON  Clear Arc\_Fault

Gen Limit Power 15000W

Load Limit Power 15000W

Grid peak-shaving Power 15000W

Auto detect Home Limit Sensors CT ratio 2000

UPS Time 0ms

CANCEL OK

ARC parameters  
030000  
045000  
000400  
000050  
000390  
000055  
238094

Basic Setup

Display Time Advanced Factory Reset Parallel

Factory Reset  System selfcheck

Lock out all changes  Test Mode

Lock Grid Charging & Limited

CANCEL OK

Basic Setup

Display Time Advanced Factory Reset Parallel

Master  Phase A

Parallel  Slave Modbus SN 00  Phase B

Phase C

Meter > Grid  Meter > Load

Meter Select No Meter

CANCEL OK

Batt Setup

**Batt Setup**

Batt Capacity: 400Ah  Use Batt V Charged

Max A Charge: 275A  Use Batt % Charged

Max A Discharge: 275A  No Battery

TEMPCO: -0mV/C/Cell  BMS Lithium Batt 00

Gen Charge  Activate Battery

CANCEL OK

**Batt Setup**

StartV: 49.0V 49.0V Float V: 55.7V

Start%: 30% 50% Absorbion V: 56.0V

A: 40A 100A Equalization V: 56.0V

30 Days 1.0 Hours

Generator Exercise Cycle Day & Time: Mon 08 :00 20min

Gen Force CANCEL OK

**Batt Setup**

Shutdown: 46.0V 20% Batt Resistance: 8mOhms

Low Batt: 47.5V 35% Batt Charge Efficiency: 99.0%

Restart: 52.0V 50%

Batt Empty V: 47.0V  BMS\_Err\_Stop

CANCEL OK

**Batt Setup**

Use gen input as load output  For AC Coupled Input to Gen

On Grid always on High Frz: 62.00Hz

Smart Load OFF Batt: 51.0V 80%  AC couple on load side

Smart Load ON Batt: 54.0V 90%

Solar Power(W): 500W

CANCEL OK

Limiter

**Grid Param**

Grid Sell: 15000

| Time    | Power(W) | Batt | Charge | Sell |
|---------|----------|------|--------|------|
| 01:00AM | 2000     | 50%  |        |      |
| 05:00AM | 2000     | 50%  |        |      |
| 09:00AM | 2000     | 100% |        |      |
| 01:00PM | 2000     | 100% |        |      |
| 05:00PM | 2000     | 50%  |        |      |
| 09:00PM | 2000     | 50%  |        |      |

CANCEL OK

**Time of Use Setup**

Mon.  Tues.  Wed.  Thur.

Fri.  Sat.  Sun.

Season1  Season2  Season3

CANCEL OK

**Grid Param**

GEN connect to Grid Input

Zero Export Power: 10W

Batt First  Load First

CANCEL OK

Grid Setup

**Grid Param**

Grid Selection: UL17415B Grid Reconnect Time: 300s

Grid Frequency: 50Hz  60Hz

Power Factor: 1.000

Fixed Q: 0%

Q\_Response: 10s

Output V: 120/208V

Output V+: +0V

CANCEL OK

**Grid Param**

| Reconnect                | Normal connect        |
|--------------------------|-----------------------|
| Grid Vol High: 228.6V    | Grid Vol High: 249.6V |
| Grid Vol Low: 183.2V     | Grid Vol Low: 104.0V  |
| Grid Hz High: 61.5Hz     | Grid Hz High: 62.0Hz  |
| Grid Hz Low: 58.5Hz      | Grid Hz Low: 57.0Hz   |
| Reconnect Ramp rate: 60s | Normal Ramp rate: 60s |

CANCEL OK

**Grid Param**

Over Voltage U>(10 min. running mean): 239.2V

| V           | F      | V            | F       |
|-------------|--------|--------------|---------|
| HV3: 249.6  | 0.16s  | HF3: 62.00Hz | 0.16s   |
| HV2: 249.6V | 13.00s | HF2: 62.00Hz | 299.00s |
| HV1: 249.6V | 21.00s | HF1: 61.50Hz | 299.00s |
| LV1: 183.0V | 2.00s  | LF1: 58.50Hz | 0.16s   |
| LV2: 145.6V |        | LF2: 57.00Hz |         |
| LV3: 104.0V |        | LF3: 57.00Hz |         |

CANCEL OK

**Grid Param**

Over frequency: Droop F: 40%PE/Hz  F(W)

Start freq F: 60.50Hz Stop freq F: 60.50Hz

Start delay: 0.00s Stop delay: 0.00s

Under frequency: Droop F>: 40%PE/Hz

Start freq F>: 59.50Hz Stop freq F>: 59.50Hz

Start delay F>: 0.00s Stop delay F>: 0.00s

CANCEL OK

**Grid Param**

Response\_T: P1:100% Lin:20.0% Lout:5.0%

|           |         |           |        |
|-----------|---------|-----------|--------|
| V1:109.0% | P1:100% | V1:90.0%  | Q1:43% |
| V2:110.0% | P2:50%  | V2:94.0%  | Q2:0%  |
| V3:111.0% | P3:0%   | V3:106.0% | Q3:0%  |
| V4:112.0% | P4:0%   | V4:110.0% | Q4:43% |

CANCEL OK

**Grid Param**

|         |        |         |          |
|---------|--------|---------|----------|
| P1:20%  | Q1:20% | V1:50%  | F1:1.000 |
| P2:100% | Q2:20% | V2:100% | F2:0.800 |
| P3:100% | Q3:20% | V3:100% | F3:0.800 |
| P4:100% | Q4:20% | V4:100% | F4:0.800 |

CANCEL OK



